



DT400
Series
Digitrax Super Throttle
Users Manual

Includes:
DT400 Series Throttles,
IR Operation with UR90, &
Radio Operation with UR91



Digitrax, Inc.
450 Cemetery ST #206
Norcross, GA 30071 USA
(770) 441-7992 Fax (770)441-0759
www.digitrax.com

Digitrax Manuals & Instructions are updated periodically.
Please visit www.digitrax.com for the latest version of all manuals.
This manual was updated 11/02.

Digitrax DT400 Series Throttle Users Manual
Includes DT400 Series Throttles,
IR Operation with UR90 & Radio Operation with UR91

Table of Contents

1.0 Introduction	4
2.0 DT400 Features and Specifications	5
3.0 Plug N' Play with your DT400	7
3.1 Turn track power on and off	8
3.2 DT400 Display Basics	9
3.3 Select & Run An Analog Loco on Address "00"	10
3.4 Decoder Address Basics	12
3.5 How To Select & Run A DCC Equipped Loco	12
4.0 DT400 Series Throttle Control Panel	16
4.1 General Information	16
4.2 L (Left) & R (Right) Throttle Knobs	16
4.3 Liquid Crystal Display (LCD)	17
4.3.1 Loco Icon	17
4.3.2 Direction Indicators	17
4.3.3 Smoke Icon	18
4.3.4 Mode Indicator	19
4.3.5 L (Left) & R (Right) Throttle Display	20
4.3.6 Text Area	20
4.3.7 L & R Bar Graph	20
4.3.8 Function Display	21
4.3.9 Track Power Indicator	22
4.3.10 Tetherless Indicator	22
4.3.11 L & R Semaphores-Cab Signaling	22
4.4 FUNC Key	23
4.5 MU Key	23
4.6 LOCO Key	23
4.7 SWCH Key	23
4.8 L & R Reverse Keys	23
4.9 Y + & N - Keys	23
4.10 DISP Key	24
4.11 PROG Key	24
4.12 EDIT Key	24
4.13 FIND Key	24
4.14 BACK Key	24
4.15 PWR Key	24
4.16 OPTN t Key	25
4.17 CLOC c Key	25
4.18 EXIT Key	25
4.19 ENTER Key	25
4.20 EMRG STOP Key	25

4.21	Full Numeric Keypad	26	16.0 Sw (Switch) Mode	55	
4.22	Infrared Emitters	27	17.0 Edit Fast Clock, Routes, etc.	57	
5.0	Track Power On/Off	27	17.1	Fast Clock Basics	57
5.1	Track Power On	27	17.2	Stop the Fast Clock	58
5.2	Track Power Off	28	17.3	Edit Fast Clock Time, Rate & Alarm	58
6.0	How To Select and Run Trains	28	17.4	Route Basics	59
6.1	The SEL Message	28	17.4.1	Enabling Routes	60
6.2	DCC Address Ranges & Display	28	17.4.2	DS54 Cascaded Routes	60
6.3	Selecting An Address On A Throttle	29	17.5	Edit Routes	61
6.4	Recall a Loco	31	18.0 FIND Key & Digitrax Transponding	63	
6.5	Stealing: Forcing An Address Selection	32	19.0 Shut Down and Resume Procedures	64	
6.5.1	Slot Following	33	20.0 Troubleshooting Throttle Problems	65	
6.6	“slot=max” Message	33	20.1	I’m lost!	65
7.0	Locomotive Speed Control	34	20.2	Emergency Stop	65
8.0	Stop	34	20.3	Nothing is responding	65
8.1	Setting A Loco to Zero Speed	34	20.4	Can’t select a loco on my throttle	65
8.2	Emergency Stop	34	20.5	“Strange” Locomotive Lights	66
9.0	Locomotive Direction Control	36	21.0 Tetherless Operation of DT400/R	66	
10.0	Controlling Functions	36	21.1	LocoNet ID Change	68
10.1	Controlling F0-F12	36	21.2	Tetherless Operation	69
10.1.1	Function 0 (F0)	37	21.2.1	Control Lock	71
10.1.2	Function 1, 3, 4, 5, 6, 7, 8, 9, 10, 11, & 12	37	22.0 DT400 Battery	71	
10.1.3	Function 2 (F2)	37	22.1	Battery Installation	71
10.2	Controlling Functions On Consisted Locomotives	38	22.2	Low Power Indicator	72
11.0	Multiple Unit Operations	39	22.3	Battery Replacement	73
11.1	Adding a Locomotive To A Consist	39	23.0 Customizing Your DT400	73	
11.2	Removing A Loco From A Consist	41	23.1	DT400 Option #1	75
11.3	Nested Consisting	41	23.1.1	Ballistic or Straight Line Tracking	75
11.4	MU of Mismatched Locomotives	41	23.1.2	Key & Knob Clicks On/Off	75
12.0	Releasing An Address From A Throttle	42	23.1.3	Local/Global Stop	75
12.1	Dispatching addresses or consists	42	23.2	DT400 Option #2	76
13.0	Programming and Configuration	43	23.2.1	Throttle Default Decoder Operation	76
13.1	Using the DT400’s key pad in Programming Mode	44	23.2.2	Tetherless Operation Mode	76
13.2	Programming Mobile Decoder Addresses	45	23.3	DT400 Option #3	78
13.3	How to Program Other Configuration Variables	47	23.3.1	LCD Backlight Brightness Setting	78
13.3.1	Hex Display & Decimal Display	47	23.3.2	Fast Clock Format	78
13.3.2	Programming CVs Other Than Addresses	48	23.3.3	Recall Stack Depth	78
13.4	Operations Mode Programming	50	23.3.4	Tetherless Release	78
13.5	Busy or Fail Message	51	23.4	DT400 Option #4	80
13.5	Reading Back CV Values Programmed	52	23.5	DT400 Option #F	80
14.0	How Your Command Station Manages Addresses	53	23.6	DT400 Option #6	80
15.0	Decoder Status	54	24.0 FCC Information	81	
15.1	Status Editing a Decoder	54	25.0 Warranty and Repair Information	82	
15.2	Note for Non-Digitrax Decoder Users	55			

1.0 Introduction

Congratulations on your purchase of a Digitrax DT400 Series Super Throttle!

The design of the Digitrax Command Control system lets you operate your layout your way. With LocoNet you simply connect system components to build the layout control system you've always wanted! The DT400 Series Super Throttle is just one of many different Digitrax Command Control components available.

Your Digitrax Command Control System has several components:

Command Station-Generates the DCC packets that tell the decoders what to do.

DCC Booster- Boosters receive DCC signals from the command station, amplify them and put them on the track along with the power from the transformer to run the locomotives. You can have several boosters on your layout to provide additional power to run more locos.

Throttle-the handheld you use to tell the command station what you want the decoders to do. You will probably have several throttles on your layout if you have more than one person running trains at a time. The DT400 is one of our most advanced throttles.

Universal Panels or Infrared or Radio Receiver Panels - memory walkaround operation or tetherless infrared or radio operation.

Mobile Decoders-installed in the locomotives to control the operation of the motor, lights and other functions of the loco.

This manual contains information about using your DT400 to run your layout with infrared and/or radio tetherless operation.

There are many different combinations of Digitrax components that you can use to set up a layout control system that is just right for you. You can combine Digitrax products with compatible decoders, boosters and computer software made by other DCC companies.

Digitrax, the Digitrax Train Logos, LocoNet, Empire Builder, Chief II, Chief, Super Chief, Super Cool, Find, Super Find, Zephyr and others are trademarks of Digitrax, Inc. This manual may not be reproduced in any form without the permission of Digitrax, Inc.

©Digitrax, Inc. All Rights Reserved. Printed in USA REV 11/01

Your success with and enjoyment of our products are very important to us. After all, this is a hobby and it is FUN!!! Please read this manual carefully before you install your system. We have included lots of hints and operating ideas based on our experience with the Digitrax system. If you have questions not covered by this manual please contact your dealer.

2.0 DT400 Features and Specifications

DT400 is designed to maintain a close similarity in function & feel with Digitrax DT300, DT200, & DT100 series throttles. This family resemblance makes it easy to add new throttles to your Digitrax Command Control System and be able to use them in ways similar to the existing throttles that you are already used to.

DT400 can be used with any Digitrax LocoNet System or other LocoNet compatible DCC system.

User friendly Multi-line Backlit LCD with easy to read icons and messages. Prompts in the display guide you every step of the way. To make operation easy and intuitive.

Dual throttle controls let you run two trains at the same time, set up and break down consists and operate prototypical helper service.

Click encoders give extra fine speed control and let you reverse the direction of the loco from a single control.

Full numeric keypad makes loco selection, programming and other functions simple.

Direct access to functions 0-12.

Single key access to most common throttle operation tasks.

InfraReady! Just add UR90 IR receivers and you are ready to run tetherless.

Find Key for use with transponder equipped locos and layouts.

Built in flashlight for reading paperwork and loco/car numbers in darkened layout rooms.

No throttle display "time outs."

Diagram 1: DT400 Hook Up

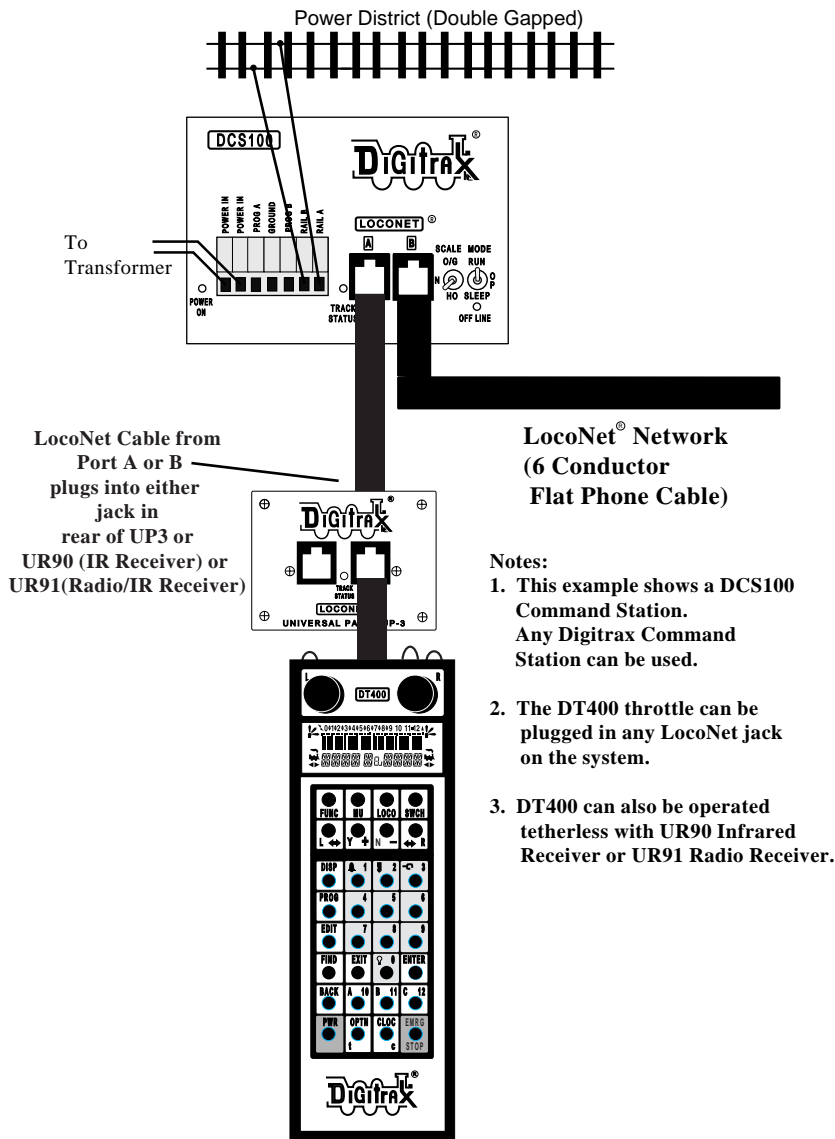

3.0 Plug N' Play with your DT400

1. Plug the DT400 series throttle into any functioning Digitrax LocoNet System or other LocoNet compatible system and you are ready to go! You can use any LocoNet jack on your system.

2. First, you will see the DT400 version number screen:

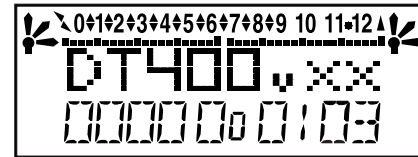

This screen shows the DT400's software version number. It is displayed for a few seconds each time you power on the DT400.

3. Next you will see the power indicator screen:

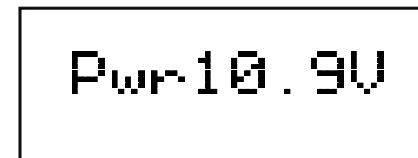

This screen indicates the power available to the throttle. When you are plugged in to LocoNet, this value will be between 9 & 15 volts. when

you insert a battery or unplug from LocoNet, the value displayed will be the battery power available. When this number is less than 6.2 volts it's time to consider replacing or recharging your battery. See section 22 for more information about using batteries with your DT400.

4. Then you will hear the throttle beep and you will see a screen similar to the following. If your throttle is a DT400R or if there is a UR90 or UR91 connected to your system see section 21 for additional information about radio &/or infrared operation of your throttles.

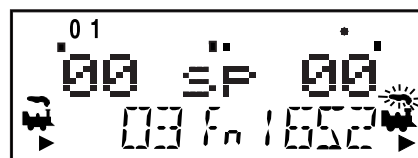

This screen displays current addresses selected on the L & R throttles along with their current speed and direction. The functions that are turned ON for the active throttle (the one with the blinking smoke icon) are displayed across the top of the display.

5. To begin operations, simply turn or single click either throttle knob or press any key to initiate any throttle task.

6. If you unplug the DT400 from LocoNet the LCD will go off while it is unplugged. It will come on again when you plug in to LocoNet again.

3.1 Turn track power on and off

The track power indicator on your DT400 shows whether track power is on or off. If the track power indicator is lit then track power is on. If it is not lit, turn track power on as follows: The throttle will prompt you with a screen similar to this:

How To Turn Track Power On and Off

1. Turn track power on:

Press the PWR Key , the DT400 will prompt you with a screen similar to this:

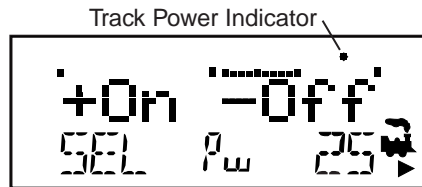



This display shows a DT400 in PWR mode.

1. Track power is currently on.
2. The L throttle does not have a loco selected.
3. The R throttle is running address 25 in the forward direction at 50% speed.
4. Press the Y+ Key to turn track power on.

Press the Y + Key  and the Track Power Indicator on your DT400 display and on your command station will come on.

2. Turn track power off:





Press the PWR Key , then press the N - Key . The Track

Power Indicator on your DT400 and on your command station will go off.

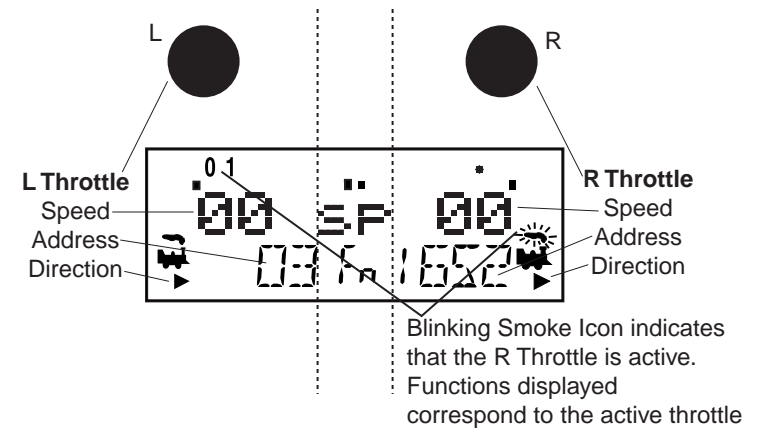
3. Exit PWR mode by pressing the PWR Key  again or by pressing any other key on the throttle to initiate the next throttle task.

3.2 DT400 Display Basics





1. The DT400 handheld has two throttles called the left throttle (L) and the right throttle (R).
2. There are two direction indicators  on the DT400. One for the L throttle and one for the R Throttle. If the direction indicator is lit, and there is smoke over the loco icon  there is an address selected on that throttle.
3. The direction indicator with blinking smoke  indicates which throttle is currently active. The active throttle is the one for which function and text information is currently displayed on the LCD screen. Also, keypad entries control functions for the active throttle.
4. The direction indicator shows the direction of travel of a DCC equipped loco selected on that throttle,  for reverse and  for forward. If you are running an analog loco, the direction indicator will only indicate change in track polarity and will not necessarily match the direction of travel of an analog loco.
5. The current mode of operation is shown in center of the bottom line of the display. The normal operating mode is Fn or Function Mode for running trains. In this mode, the throttle knobs and direction keys control the speed and direction of the locos. The Y + & N- Keys can also be used to increase or decrease speed. The numeric keypad is used for direct access to functions.

For example, in Fn mode, to increase speed you can either turn the throttle knob clockwise or press the Y + Key. To change the loco's direction you can either double click the throttle knob or you can press the reverse key associated with the throttle you are using. To access functions on the active address you are controlling, simply press the numeric key that corresponds to the function you want to activate or deactivate. When you are in switch mode, the keypad is used for entering switch commands while the throttle knobs and direction keys continue to run the trains.

The following examples will help you learn about your new DT400. The first example shows how to select and run an analog loco, the second example shows how to select and run a DCC equipped locomotive. Once both locos are selected on your throttle, you can run them both at the same time.

3.3 Select & Run An Analog Loco on Address "00"

1. Place an analog locomotive (one without a decoder) on your layout. While the analog loco is sitting still, you will hear the characteristic "singing" caused by the DCC track signal when it is applied to analog locomotives. Once the analog loco is moving, this sound will change and be less noticeable. (Digitrax recommends that analog locos not be left sitting on DCC powered track for long periods of time when they are not running.)
2. Check the track power indicator on your DT400's LCD to be sure that track power is turned on.
3. Activate the DT400's right throttle knob "R" by turning it a 1/4 turn in either direction or by pressing down on the R Throttle knob once. The R Address will start flashing. If nothing is selected on this throttle it will flash "SEL".
4. Press the LOCO Key . The LCD will show the last address used and the current decoder status of that address. The DT400 gives you two options for choosing the address you want to run: throttle knobs or direct keypad entry. Either use the R Throttle knob to dial up "00" in the R Address display or press 00 on your keypad. Press the LOCO Key  again to select address 00 on the throttle. The icon and the address will be blinking until you complete your selection by pressing the LOCO Key the second time or exit the loco selection mode by pressing another key to begin another throttle

task. The EXIT Key can be used at any time to return to Fn mode for normal loco operation.



This illustration shows what will be on your LCD when you press the LOCO Key to select an address on the R Throttle if address "00" was the last address selected on the R Throttle and where no address has been previously selected for the L Throttle.

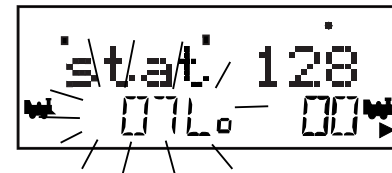

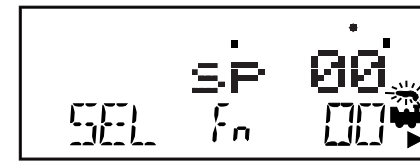

As you browse through decoder addresses, their current status will display on the screen.



This illustration shows the LCD after pressing the LOCO Key to complete the selection process. Loco address 00 is selected on the R Throttle and is not moving.

5. Turn the R Throttle Knob clockwise slowly to increase the speed of the analog locomotive. As the speed increases, the locomotive on the track will begin to move. Your command station's TRACK STATUS indicator should change color as you change the speed setting.

6. Press the R Reverse Key  on the right side of the DT400 or double click* the R Throttle knob to reverse the direction of the analog loco. The R direction indicator will toggle between  and . The indicator will change each time you press the direction key but, in the case of the analog loco the indicator only indicates a change in track polarity-NOT THE ANALOG LOCO'S DIRECTION.

*To double click the throttle knob, quickly press down on the throttle knob twice within about 1/2 second. You will hear a click each time you press down on the throttle knob.

7. Turn the R Throttle knob counterclockwise to 0% speed to stop the analog loco.

3.4 Decoder Address Basics

Each DCC decoder has an address that is used by the system to send commands to that decoder. To select a DCC locomotive and run it on either throttle, you must know its address. Digitrax decoders are set up at the factory with the “default” 03. This means that when you take a Digitrax decoder out of the package and install it in your loco, you can select address 03 on your throttle and run the decoder. The first CV programmed by most DCC users is the decoder’s address since it is not very useful to have all of your locos run on address “03.” If you do not know the address of the DCC locomotive you want to run, you can simply program the decoder’s address and select it to run using the new, known address. With some command stations, it is possible to read back the decoder’s address. See your Digitrax Starter Set Manual for information about reading back addresses and see your Digitrax Decoder Users Manual for a complete discussion of decoder addressing.

3.5 How To Select & Run A DCC Equipped Loco

1. Activate the DT400’s left throttle knob “L” by turning it a 1/4 turn in either direction or by clicking the throttle knob once. The left side address will begin flashing. If nothing is selected on this throttle it will flash “SEL”.



2. Press the LOCO Key . The left side of the display will begin flashing.



The illustration above shows the LCD display just after you press the LOCO Key to select an address on the L Throttle when nothing has been selected on that throttle before and where address “00” is selected to run on the R Throttle.

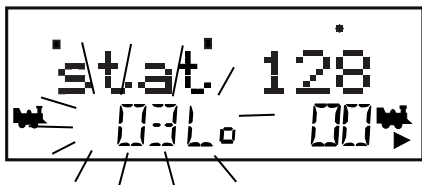

3. Use the numeric keypad to enter 03 or use the R Throttle knob to select Address “03” in the left side of the display. (The R Throttle knob changes 1s and 10s, The L Throttle knob changes 100s and 1000s.) The display will show the current status of the address.

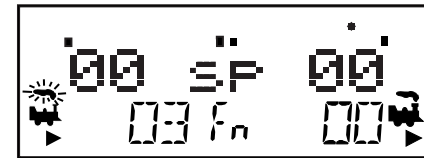

4. Press the LOCO Key  to select address 03 on the L throttle.
5. The left loco icon will appear in the display with a direction arrow and “blinking smoke” . The “blinking smoke” indicates which side of the throttle is displaying function information on the top line of the LCD.



The illustration above shows the LCD after address “00” is selected on the R Throttle and address “03” is selected on the L Throttle. We see the Power On Indicator in the top line, the speed bar graphs at 0 speed and the text area also at 0 speed for both throttles.

6. Use the L Throttle knob to run the DCC equipped locomotive on address 03. As the value in the left display increases, the locomotive with decoder address 03 on the track will begin to move. Press the L Reverse Key  on the left side of the DT400 or double click the L Throttle Knob to reverse the direction of the locomotive.
7. Turn the L Throttle knob counterclockwise to 0 speed to stop the loco.
8. Use the R Throttle knob and R Reverse Key  to control the analog loco and the L Throttle knob and L Reverse Key  to control the DCC equipped loco. You can control both at the same time.

Throttle in normal operations mode indicated by Fn.
 In Function (Fn) Mode
 Throttle knobs control Loco's Speed & Direction
 Keypad entries control functions

Track Power Indicator ON

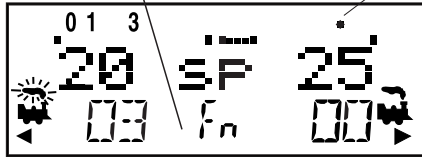

2 digit address 03
 Selected on the L Throttle
 Running at 20% speed
 In reverse
 Function 0, 1, & 3 on.

An analog loco address 00
 Selected on the R Throttle
 Running at 25% speed
 The direction arrow below the Loco Icon **does not** indicate actual direction for Analog locos.

Notice as you use each throttle knob or direction key that the loco with the “blinking smoke” will change to that side of the throttle. The side with the “blinking smoke” indicator is the active throttle. To control the headlight or other functions, the locomotive must be on the active throttle.

By now you are running two locomotives (one analog and one DCC) and you have learned some of the key concepts of using the DT400! Please read the following sections for more in depth information about other features & capabilities of the DT400 throttle.

Diagram 2: DT400 Throttle Controls

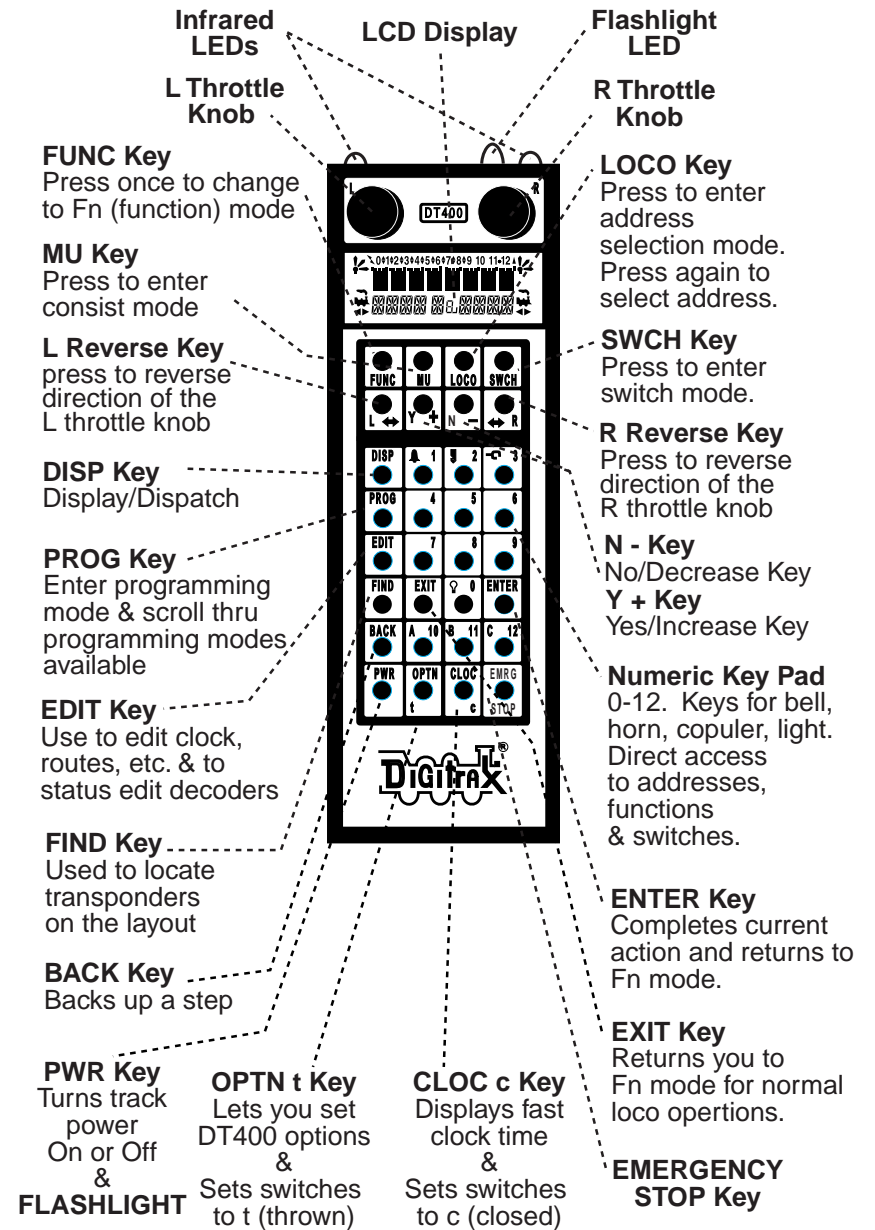

Remember, the EXIT Key will take you back to the Fn Mode for Normal Loco Operations.

4.0 DT400 Series Throttle Control Panel

4.1 General Information

The DT400 and DT400R are full function hand held throttles that include 2 independent throttles and a common keypad to control, up to 13 functions (0-12), turnouts and programming. The DT400 does not require a battery in normal walkaround operation. If you do not install a battery, the throttle display will be off while you are unplugged from the system. The DT400 requires a 9 volt battery for infrared operation. The DT400R requires a 9 volt battery for radio operation.

4.2 L (Left) & R (Right) Throttle Knobs

Throughout this manual we refer to the throttle knob on the left side as the L Throttle and the throttle knob on the right side as the R Throttle. This corresponds to the L & R that appears on the throttle.

The throttle knobs on the DT400 use “encoders.” They give very smooth, fine speed control. In 128 speed step mode it takes four complete rotations of the knob to go from stop to full speed. When you select a locomotive that is already moving on either throttle knob, that throttle will continue to run the locomotive at the same speed and in the same direction in which it was traveling before being selected to the throttle.

As you turn the DT400 throttle knobs you will feel a mechanical detent (and hear a beep if your throttle is set up for beeps and clicks). Each time you move the knob, the system processes information. In some cases, the LCD display will not change each time you feel the detent. In the case of increasing and decreasing loco speed, this is because each detent does not equal an increase of 1% speed. If your DT400 is set up for ballistic tracking, the speed with which you move the encoder will affect how the display changes.

You can customize the tracking characteristics of these knobs for either **straight line (normal) tracking or ballistic tracking**. With straight line tracking each movement of the knob causes a fixed rate of change. With ballistic tracking, the faster you increase or decrease the the throttle knob, the faster the data changes in the throttle. Your DT400 was shipped with ballistic tracking as the factory default setting. To change this setting see Section 23.1.1.

The throttle knobs on the DT400 can also be used to access the recall stack and select a locomotive to run on a throttle or to reverse the direction of the locomotive currently selected on that throttle.

When dialing up numbers with the throttle knobs, the R Throttle knob changes 1s and 10s and the L Throttle knob changes 100s and 1000s. This makes the throttle knobs easy to use when dialing up four digit addresses.

If you prefer larger throttle knobs, simply remove the 1/2” knobs that come standard with the DT400 by pulling gently and replace them with larger knobs (up to 1.25”).

4.3 Liquid Crystal Display (LCD)

Diagram 3: DT400 LCD

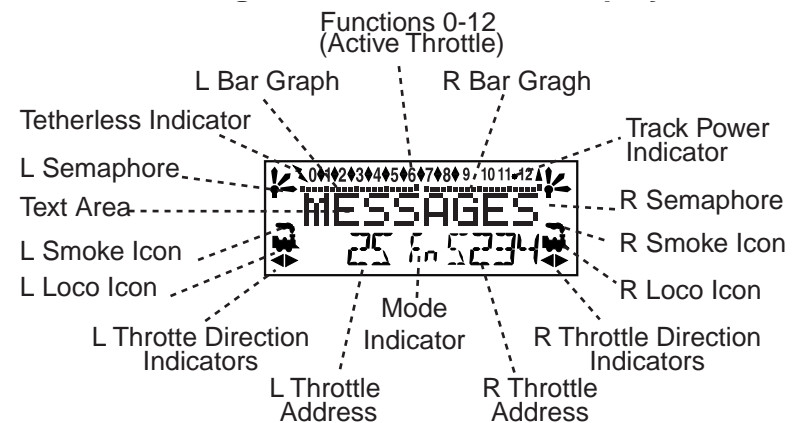

4.3.1 Loco Icon

The L & R Loco Icons  are used to indicate whether an address is available for selection. A blinking loco icon means that the address is available for selection and a steady loco icon means that the loco address is currently selected or in use by another throttle.

4.3.2 Direction Indicators

The direction indicators  are located in the LCD Display of the DT400 directly below the Loco Icon. There are separate indicators for the L (left) and R (right) throttles. If the arrow points to the front of the loco, the throttle is in the forward direction. If the arrow

points to the back of the loco, then the throttle is in the reverse direction. If there is not a locomotive selected on a throttle the loco icon will not appear.

 = Forward Direction  = Reverse Direction

Note: These direction indicators are for DCC equipped locos only. They will indicate direction based on the normal direction of travel that you set up for your DCC equipped loco. If you are using an analog loco, the direction indicator may or may not match the actual direction of the analog loco.

4.3.3 Smoke Icon

The Smoke Icon is located just above the Loco Icon. Both the L & R Throttles have a smoke icon. If a loco is selected on either throttle, the Loco icon will appear beside the address of that loco. If nothing is selected, there will be no Loco icon and the address area will show SEL. The blinking smoke icon indicates which throttle is currently active (having its function states displayed in the top line of the LCD). Since both throttles must share the keypad, only one at a time can have access to the keypad and function controls. The active throttle has access to the function controls and the status of the functions for the active throttle are displayed in the top line of the LCD. To make either throttle the active throttle simply click it once or turn the Throttle knob a little.

No Loco Icon = nothing selected on this side of the throttle

 Loco with steady smoke = Keypad and function display not active for locomotive address selected on this throttle.

 Loco with flashing smoke = Keypad and function display active for the locomotive address selected on this throttle.

4.3.4 Mode Indicator

The mode indicator, located at the bottom center of the LCD, shows the DT400's current mode of operations.

Table I: DT400 Mode Indicator Display

Display	Mode	Used For
Fn	Function	Normal locomotive operation functions available on keypad
Lo	Loco Selection	Locomotive Address Selection Mode
Mu	MU	Multiple unit (consist) operation set up and break up
Sw	Switch	Accessory decoder control (turnouts, etc.) or option switch control
Pw	Power	Turn track power on and off
SE	Status Edit	Change locomotive speed steps to 14, 28, or 128 as needed
Pg	Programming	Paged-Digitrax preferred method
Ph	Programming	Physical Register
Pd	Programming	Direct
Po	Programming	Operations Mode (Ops Mode) programming on the mainline.
RE	Recall	Recall one of the last 4, 8, or 16 locomotive addresses used
Fd	Find	Find command issued for active loco, results displayed in text area.
Ec	Edit fast clock	Edit the time shown on the fast clock
EF	Edit fast clock rate	Edit the fast clock rate
EA	Edit alarm	Edit the alarm time set for the throttle
Er	Edit routes	Edit routes -shows when your system is running with a DCS100 with routes enabled
E1	Change LocoNet ID	Change LocoNet ID for Infrared or Radio Operation
E?	Other edit modes	Show when your system is running with a LocoNet component that is enabled for additional functionality such as signaling.

The DT400 automatically defaults to the Fn mode & returns to this mode when ever the EXIT Key is pressed. **The Mode indicator usually shows what the numeric keys are associated with.** For example, in Fn mode, any entry on the numeric keypad will affect functions. In Sw mode, keypad entries will change turnouts and in Lo mode, entries on the keypad will enter loco address numbers, etc.

4.3.5 L (Left) & R (Right) Throttle Display

The decoder address selected on the L Throttle is displayed on the bottom line of the LCD to the left of the Mode Indicator. The decoder address selected on the R Throttle is displayed on to the right of the Mode Indicator. The address can show as either the 2-digit or the 4-digit decoder address. If no address is selected the display will show "SEL." If a 2-digit address is selected (00-127), the display will show two or three digits. If a 4-digit address is selected (0128 - 9983), the display will show all four digits including the leading zero.

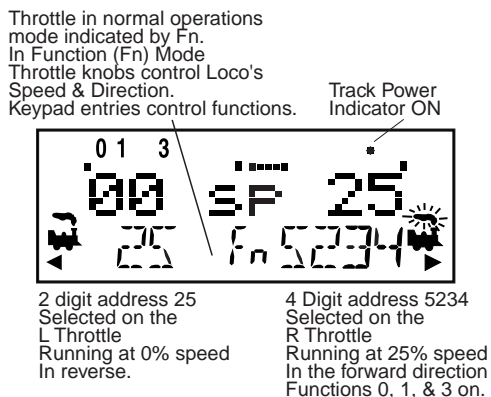

4.3.6 Text Area

The Text Area of the LCD consists of the eight characters in the middle line of the display. This is where information like locomotive speed, decoder status, turnout position, fast clock, text prompts, messages and programming data are displayed.

4.3.7 L & R Bar Graph

Each throttle has a bar graph located above the text area of the LCD. Each of these indicates the speed setting of the L & R Throttles graphically from a single dot (0% throttle) to 20 dots (full throttle).

This is useful when the text area is showing information other than speed.

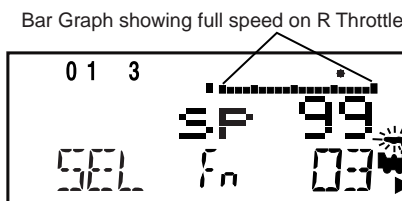
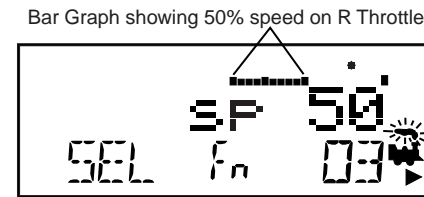
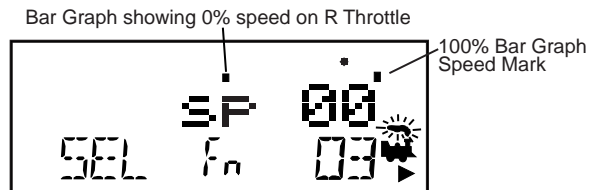

4.3.8 Function Display

Whether functions 0-12 are on or off for the currently active loco address they are displayed on the top line of the LCD. The functions for the active throttle (the one with blinking smoke) are displayed. To view the function status of either throttle, simply press the throttle knob to display the active functions for that throttle.

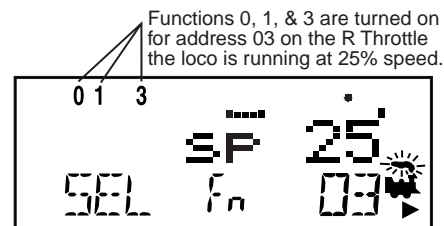

4.3.9 Track Power Indicator

This very small star shaped dot (shown larger than life above) located in the top line of the LCD on the right side indicates the status of the track power.

No indicator = System track power is OFF (Press PWR followed by N-)

Indicator On Steady = System track power is ON(Press PWR followed by Y+)

Blinking Indicator = System is in “STOP” and track power is ON (Press PWR followed by Y+ and Y+ again)

4.3.10 Tetherless Indicator

The tetherless indicator shows when your throttle is using either infrared or radio communications.

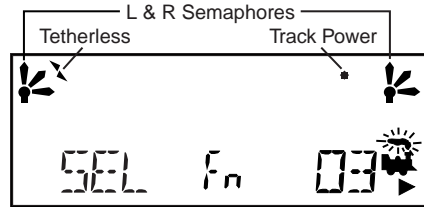

4.3.11 L & R Semaphores-Cab Signaling

The L & R Semaphores are used when cab signaling is implemented on the layout. More information about signaling and detection will be available on our web site, www.digitrax.com as these products become available. Information on how to activate these indicators will be included in the manuals for our detection and signaling products. Information will also be available from other LocoNet Certified manufacturers when they have implemented these features in their software.

The L & R Semaphores will display the following:

- ! = Clear
- ↗ = Approach
- = Stop

4.4 FUNC Key

The FUNC Key  is used to enter function control mode. Function control mode is the default mode for normal locomotive operation with the DT400. Press this key during any throttle task to return to normal loco operation mode with function controls active on the numeric keypad.

4.5 MU Key

The MU Key  is used to enter consist set up mode. Once the MU Key is pressed, you will be prompted by the throttle to use the Y+ Or N- Keys to add locos to or remove locos from consists.

4.6 LOCO Key

The LOCO Key  is used for selecting loco addresses on to the throttles so that the address is controlled by the throttle. Sometimes people call this “assigning locos to throttles.” DT100, DT200, & DT300 series throttles use the SEL or SET/SEL Keys for this throttle task.

4.7 SWCH Key

The SWCH Key  is used for entering switch control mode. Once this key is pressed, you will be prompted to select a switch address and issue a thrown or closed command. Switch control mode is used in normal operation for operating turnout machines and in set up mode for setting up option switches in the throttle and command station.



4.8 L & R Reverse Keys

The L & R Reverse Keys change the direction of travel of the loco on the related throttle when the throttle is in Fn (Normal Operation) Mode. The R

Reverse Key  changes direction of the address on the “R” or Right

Throttle. The L Reverse Key  changes direction of the address on the “L” or Left Throttle.

4.9 Y + & N - Keys

The Y +  and N -  Keys are used:

- to turn track power on and off,
- to increase or decrease loco speed.
- to link and unlink locos during MU'ing.
- to accomplish tasks using system editors.

These keys can be set up to act in two different ways:

Repeating (also called typematic) so that if you hold a key down it will continue to increase or decrease step by step until you release the key. This option is active when your throttle is set up for ballistic tracking. Your DT400 was shipped from the factory with this feature enabled.

Single Press so that you will must press the key each time you want to increase or decrease. This option is active when your throttle is set up for straight line tracking.

See Section 23.1.1 for information on changing this setting on your DT400.

4.10 DISP Key

The DISP Key  is used for displaying programming information and dispatching loco addresses.

4.11 PROG Key

The PROG Key  is used to enter programming mode and to toggle among the programming modes available for use.

4.12 EDIT Key

The EDIT Key  is used to enter the Edit Mode for editing the fast clock, routes, signaling, etc. It is also used to status edit decoders while in locomotive address selection mode.

4.13 FIND Key

The FIND Key  is used in conjunction with a layout instrumented for Digitrax Transponding and locos or cars equipped with transponders to find the location of those pieces of rolling stock on the layout.

4.14 BACK Key

The BACK Key  is used to go back one step.

4.15 PWR Key

The PWR Key  is used to enter power mode for turning layout power on and off. Once you press this key, you will be prompted to use the Y+ key to turn power on or the N- Key to turn power off.

The PWR Key is also used to turn on and off the flashlight feature. The flashlight LED will be on as long as you hold down the PWR Key.

4.16 OPTN t Key

The OPTN t Key  is used to enter the Option Mode to set throttle and system options. It is also used to issue t (thrown) commands when the throttle is in Switch mode.

In the case of turnout control:

 t=thrown, turnout is set for the diverging route through the curved leg.

4.17 CLOC c Key

The CLOC c Key  is used to toggle between displaying and not displaying the current fast clock time. It is also used to issue c (closed) commands when the throttle is in Switch mode.

In the case of turnout control:

 c=closed, turnout is set for the main line with routing through the straight leg of the turnout.

4.18 EXIT Key

The EXIT Key  is used to exit the current throttle task without making changes. Pressing this key will usually return the DT400 to Fn mode for regular locomotive operation.

4.19 ENTER Key

The ENTER  is used to complete the current throttle task and return to Fn mode for normal operations.



4.20 EMRG STOP Key

Your DT400 comes from the factory set for “Local” Stop. When you press

the EMRG STOP Key , the loco address that is active on your display (the one with the blinking smoke) will stop. When you press the EMRG STOP Key

 again, the loco address on the other throttle of your DT400 will stop.

You can use the OPTN t Key to change the EMRG STOP to “Global” Stop. See Section 23.1.3 for instructions.

With global stop option enabled, pressing the EMRG STOP Key  will stop all locos on the layout and you will see the DT400’s track power indicator blinking on and off. To resume operations, press the PWR Key  followed by the Y + Key  to return locos to their speed prior to the EMRG STOP. Press EXIT to leave Pw mode and return to Fn mode after turning track power back on with PWR & Y+ Keys.

4.21 Full Numeric Keypad

The numeric keys on the keypad are usually related to the throttle mode shown in the LCD’s mode indicator area. For example, when the mode is Fn, the numeric keys are used for function control. When the mode is Lo, the numeric keys are used to enter loco addresses. When the mode is Sw, the numeric keys are used to enter switch addresses.



The 0-12 Keys allow direct entry of loco and switch addresses as well as CV values during selection and programming. These keys also give direct access to functions 0-12 during normal operation of locos. Special number keys:

 The Lamp 0 Key is most often used to turn on and off the loco’s head lights. It can also be used for other functions as desired.

 The Bell 1 Key is most often used to turn on and off the bell sound in locos equipped with sound decoders.

 The Horn 2 Key is most often used to turn on and off the horn sound in locos equipped with sound decoders. This function key is a momentary key that will activate the sound as long as the key is held down. It can be latched on by pressing the PWR Key while holding the Horn 2 Key down. This key also pressure sensitive to allow for the use of sound decoders that incorporate a “playable whistle.”

 The Coupler 3 Key is most often used to activate couplers. It can be used for any function.

   The A10, B11 & C12 Keys make it easy to use functions 10-12 and give more flexibility for future features by providing A, B & C as possibilities.

4.22 Infrared Emitters

Your DT400 has two infrared LEDs in the cable end of the throttle. These emitters send infrared signals that can be used by LocoNet compatible Infrared receivers to give you tetherless operation. See Section 21 for infrared operation information.

5.0 Track Power On/Off

5.1 Track Power On

When track power is on:

- DT400’s Track Power Indicator is on (small dot in the top line on the right side of the LCD)
- Command Station TRACK STATUS indicator is lit and
- Command Station OFF LINE indicator is off.

To turn track power on: Press the PWR Key  the LCD will display a screen similar to this:

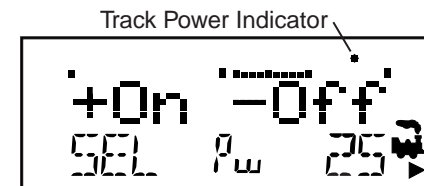

This display shows a DT400 in PWR mode.

1. Track power is currently on.
2. The L throttle does not have a loco selected.
3. The R throttle is running address 25 in the forward direction at 50% speed.
4. Press the Y+ Key to turn track power on.

Press the Y + Key  to turn on track power. Press the PWR Key again to exit Power On/Off Mode. You may also press any other key to go directly to the next throttle task you wish to perform.

If you press the Y + Key  two times, you will see the DT400 Track Power Indicator blink to indicate that the system is in “STOP” with track power on.

Simply press the Y + Key  a third time to toggle back to system “GO” and track power on.

5.2 Track Power Off

When track power is off:

- DT400 Track Power Indicator is off (track power indicator is a small dot in the top line on the right side of the LCD)
- Command Station TRACK STATUS indicator is off and
- Command Station OFF LINE indicator is on.

To turn track power off: Press the PWR Key  the LCD will display “+ On - Off”. Press the N - Key to turn off track power. Press the PWR Key again to exit Power On/Off Mode. You may also press any other key to go directly to the next throttle task you wish to perform.

6.0 How To Select and Run Trains

Function or “Fn” mode is the default mode for the DT400 because it is the mode that runs your trains. In Fn mode, the throttle knobs, reverse direction keys and Y+/N- keys are used to control locos. The numeric keypad is used to access functions for the currently active loco address and to operate switches when switch mode is in use. This means that you can continue to control your trains while turning on and off functions and operating turnouts.

If a throttle has a locomotive address selected, the associated loco icon and direction indicator will be lit. In addition, if the smoke above the locomotive icon is flashing, this indicates that this is the currently active throttle meaning that the Function keys on the throttle and the Function Indicators in the display are associated with that address.

To make the other throttle active, simply turn or click the other throttle knob. The smoke will start blinking on the other throttle and the function information will be displayed for that loco address.

6.1 The SEL Message

If a throttle knob does not have a locomotive selected when you make it active by turning or pressing the L or R Throttle knob or Reverse Key, flashing “SEL” will appear in place of the locomotive address in the LCD display. This is a prompt for you to select a locomotive on that throttle.

6.2 DCC Address Ranges & Display

There are three address ranges available for addressing and programming locomotives. You can use all three address ranges at any time and in any combination you choose.

Address 00: The analog address used to run locomotives without decoders. All analog locos on the layout will respond to the speed and direction commands issued to address 00.

2 digit addressing: Addresses in the range of 01 through 127. Also called short addressing. 2 digit addressing can be used with any DCC decoder.

4 digit addressing: Addresses in the range of 0128 to 9983. Also called Extended Packet Format or long addressing. Four digit addressing can be used with any DCC Extended Packet Format, or EPF, decoder that supports this four digit addressing. The decoder must also be set up to enable 4 digit addressing.

The DT400 does not support aliasing of 2 digit addresses.

When the DT400’s LCD displays a 2 digit (00 - 127) address, only the 2 or 3 digits of the address will appear in the display. When the LCD displays a 4 digit address (0128-9983), all four digits including any leading 0s will be displayed. Example: 127 is a 2 digit address and the display will read 127. 0128 is a four digit address and the display will read 0128.

6.3 Selecting An Address On A Throttle



1. Choose which Throttle (L or R) you want to use to run a locomotive. Make it the active throttle by turning it a 1/4 turn in either direction or by single clicking the throttle knob. If there is an address selected to the throttle, the smoke icon will be blinking.
2. Press the LOCO Key . The active throttle display will begin flashing the Loco Icon, the last loco address selected on the throttle and the Lo mode indicator. The Text Area of the display will show the status of the last loco address selected (usually “stat 128” for Digitrax decoders). “Sel Loco” will be displayed in the Text Area if no loco address was previously selected.
3. To select a 4 digit address, use the numeric keypad to key in the address of the loco you want to run OR use the L Throttle knob to dial up the first two digits (1000s & 100s) of the address you want to select and use the R throttle knob to dial up the last two digits (10s & 1s) of the address you want to select. Alternately, you can use just the R Throttle knob to browse from address 00(analog) to 01-127(2 digit addresses) to 0128-9983(4 digit addresses).

NOTE: When you enter a four digit address from the keypad, the display will show the address as a two digit address and then a four digit address as you enter the numbers. For example, when you enter address 5786, you will see the following sequence of displays:

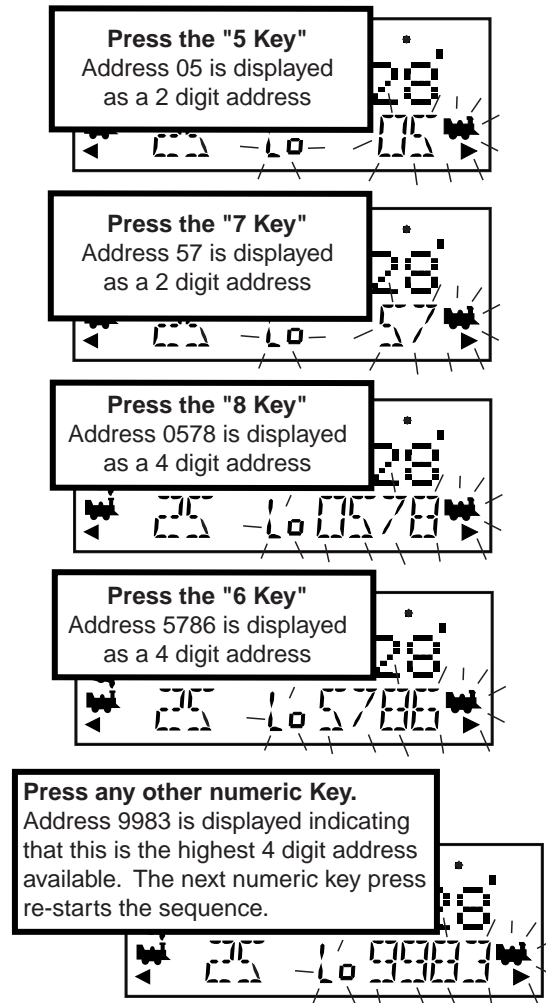
Use the DT400 keypad to enter address 5786 and you will see the following sequence of displays.



- To select a 2 digit address, use the keypad to enter the address of the loco you want to run OR turn the L throttle knob counterclockwise until you see 00 appear in the display, then use the R throttle knob to dial up a 2 digit address between 00 & 127.

- As you browse through addresses, the LCD will display current information for each address including current speed on the bar graph, current status in the Text Area, active functions on the top line of the LCD. The Loco icon will blink if the loco address is selectable and will be steady if the loco is selected on another throttle. If the Loco Icon is steady, see Section 6.5 for information on "stealing."
- Once the address you want to select is displayed, press the LOCO Key  once again to select this address on the active throttle. Pressing the ENTER Key or single clicking the throttle knob will also select the address shown in the display. The LCD screen will show the locomotive's address, speed information & functions on/off for the loco you just selected.
- The loco icon will appear in the display with a direction arrow and blinking smoke.  The blinking smoke indicates which side of the throttle is active (is displaying function information on the top line of the LCD).
- Use the active throttle knob to run the DCC equipped locomotive on the address you selected. As the % speed value displayed in the left side of the LCD increases, the locomotive on the track will begin to move. Press the Reverse Key associated with the active throttle to reverse the direction of the locomotive. Note: Double clicking the active throttle knob will have the same effect as the Reverse Key.

6.4 Recall a Loco

Your DT400 stores the last 4, 8, or 16 unique loco addresses used by the throttle in a recall stack. Your DT400 defaults to a 4 address recall stack. See Section 23.3.3 for information on how to set the recall stack depth.

For example if you have your DT400 set up for an 8 deep recall stack and the last 8 addresses you selected were: 00, 1987, 52, 0678, 03, 8819, 25, and 2500, these addresses will be in the recall stack. If you have selected any of these addresses more than once, it will not be stored twice, only the addresses not already stored will be added to the stack. The recall stack is not stored in numeric order. This makes it convenient to select locos that you have used previously without having to dial up the address.

To Recall the last 4, 8, or 16 addresses on the R Throttle





1. Press and hold the R Throttle knob. The word “Recall” will appear in the text line.
2. When “Recall” appears in the display, release the knob. “RE” will appear in the mode indicator in the center of the bottom line on the LCD. The right side address display will begin to flash prompting you to select a locomotive.
3. Turn the R throttle knob to browse through the last 4, 8, or 16 addresses selected in the system. Whether you browse 4, 8 or 16 addresses depends on how you set up your throttle’s options. As you browse through the addresses, the throttle will display their current speed on the bar graph and their status in the text line of the LCD. Addresses are displayed in the order they were used by the throttle (not in numeric order).
4. Press and release the R Throttle knob or the LOCO Key  to select the desired loco address. Once the locomotive is selected the R Throttle knob will be able to control the speed control and direction of that locomotive.

Follow the same procedure to Recall a locomotive on the L Throttle by using the L throttle knob.

6.5 Stealing: Forcing An Address Selection

If you try to select a loco address that is already selected on another throttle the DT400 will display “Steal?=Y” in the text area. This is a safety interlock to prevent operators from taking control of locos that are already selected on other throttles. Occasionally it is necessary to override this interlock to gain control of a loco that is “lost” for whatever reason. This override is called stealing & can result in having a single loco address selected on two different throttles at the same time.

To steal an address with the DT400:

1. Press the LOCO Key  to enter selection mode.
2. Dial up the address of the loco you want to steal and press the LOCO Key  again.
3. The DT400 will display “Steal?=Y” in the text area if the loco can be stolen.
4. Press Y + Key  if you want to steal.
5. Press N -  (or any other key) if you do not want to steal.

Once a throttle has “stolen” a loco address, the slot following mode becomes

active and both throttles will update speed and direction information for the loco address. This can result in strange locomotive behavior especially if one throttle is trying to stop the loco and the other is trying to speed it up at the same time.

When you have gained control of the stolen loco and are finished running it, release it from your throttle by setting the loco’s speed to 0 and pressing the LOCO Key followed by the DISP or EXIT Key. See Section 12 for more information about releasing an address.

6.5.1 Slot Following

When a DT400 detects that a loco address that is in-use on one of its throttles is being changed by another throttle or computer, it will cause the DT400 to “click” every time it sees a remote throttle change its locomotive settings. If that locomotive is in the active throttle, its speed display will also show the changes. This is called slot following. This allows two DT throttles to run a single locomotive address with both throttles being able to send commands to the loco. Both throttles will show the current speed and direction of the locomotive in their displays.

Slot following is useful for training new operators. The supervisor can “steal” a locomotive that is selected on a trainee’s throttle & be able to “look over the trainee’s shoulder” and closely supervise that locomotive’s control. The supervisor can gain instant override control without having to physically “grab” the trainee’s throttle. This lets you have unskilled visitors participating and enjoying operations without too much anxiety for either party.



Slot following also allows a computer on LocoNet to run CTC & routing control programs with automated control over locomotives. The computer can control speed and stop engines automatically while letting the engineer with the throttle in his hand know what is happening.

6.6 “slot=max” Message

If the text area of the DT400 shows the message slot=max during the selection process this means that the command station reached the limit of locomotive addresses that it can manage at one time. If you want to select additional addresses, you will need to release one or more loco addresses to continue the selection process.

7.0 Locomotive Speed Control

To control the speed of a locomotive:

1. Select the loco address on either throttle
2. Turn the throttle knob clockwise to increase speed and counterclockwise to decrease speed or
3. Use the Y +  & N-  Keys to increase and decrease speed.

The % of full speed will be displayed in the text line of the display on the L or R side depending on which throttle is controlling the loco. The % of full speed will also be displayed on the bar graph above the text area in the display.

If a loco address is part of a consist and is not the “TOP” (or controlling locomotive) and you try to change its speed the LCD screen will show “cn” in the text area where % speed would normally appear. The “cn” lets you know that the loco you have selected is part of a consist and that you cannot change the speed or direction of this loco independently of the consist.

8.0 Stop

8.1 Setting A Loco to Zero Speed

Turn the Throttle Knob that the loco address is selected on counterclockwise until the speed display shows 00 and the loco stops moving. This lets you slow down your loco and stop it prototypically.

If you have set up deceleration for the loco and you move the throttle knob to 0% speed, your loco will slow down and come to a stop at the programmed deceleration CV value. We strongly recommend that you run your locos with the factory default of no deceleration until you are familiar with your system.

If the deceleration CV value you set for a particular loco is very large, this can make it look like the loco is not stopping on command because the deceleration CV value is causing the loco to take a long time to come to a stop.





8.2 Emergency Stop

DT400s have two ways of causing an emergency stop. When you use emergency stop, the deceleration rate programmed into the decoder will not have an effect and the stop will be immediate.

Local Stop

Press the EMRG STOP Key  to stop the loco that is active in the DT400's display. To resume operation, use the throttle knob associated with that address to increase the loco's speed.



Press the EMRG STOP Key  again to stop the loco that is associated with the other throttle on the DT400. To resume operation, each operator must use their throttle to set their loco's speeds back to the desired speed.

To stop everything on the layout, press the PWR Key  followed by the N - Key  while the track power is on. This will turn track power off and will cause all locos to stop. Press the PWR Key  followed by Y + Key  again and the locomotives will start running again at the same speed they were running prior to STOP mode. To exit PWR mode, press the PWR Key or the EXIT Key.

Global Stop

See Section 23.1.3 for setting the DT400 Options for Global Stop.

Press the EMRG STOP Key  to stop all locos on the layout.

To resume operations, press the PWR Key  followed by the Y + Key  again and the locomotives will start running again at the same speed they were running prior to STOP mode. To exit PWR mode, press the PWR Key or the EXIT Key.



Turning track power off will also cause an emergency stop. Press PWR Key followed by the N-Key to turn track power off. Press the Y+ key to turn track power back on. See section 5.2 for information on turning track power off.

9.0 Locomotive Direction Control

Double click the Throttle Knob to reverse the direction of a locomotive running on that throttle:

1. Double click the Throttle knob that is controlling the locomotive. Press down on the knob quickly two times (2 distinct key presses within 1/2 second).
2. The locomotive selected on that throttle will change direction.
3. Repeat the process to reverse again, etc.
4. Double clicking the R Throttle knob will reverse only the locomotive running on that throttle. Double click the L Throttle knob to reverse in the same way.

Use the L or R Reverse Keys to reverse direction:

Press the L  & R  Reverse Keys to reverse the direction of the locos selected on the respective throttles.

The R Direction Indicator under the R Loco Icon  in the LCD will indicate the direction of the loco.

If you change direction while a loco is moving it will slow down to 0 speed and then speed up to the commanded speed according to the decoder's programmed CV values for deceleration and acceleration.

You can set up (program) each decoder with acceleration and deceleration rates that simulate the scale effects of braking the train. Then when you command an instant reverse, the system will simulate braking by slowing down the locomotive at the programmed deceleration rate, come to a stop & then accelerate at the programmed acceleration rate in the opposite direction.

10.0 Controlling Functions



10.1 Controlling F0-F12

To enter Fn (function) mode:

1. Determine which throttle you want to control functions on and make it the active throttle by single clicking the throttle knob or by turning the throttle knob a couple of clicks.
2. DT400's numeric keypad is always active in function mode during normal loco operations. When the mode indicator on your DT400 shows Fn, simply press any number on the keypad to activate or deactivate any function. The functions that are currently on for the active loco will be displayed on the top line of the LCD.

3. If the Mode indicator does not show Fn, press the FUNC Key  once to enter the function mode for the active throttle. The Mode Indicator in the center of the lower line on the LCD will show Fn (function mode).

10.1.1 Function 0 (F0)

Press the LAMP 0 Key  to toggle F0 between on and off. Each time the LAMP 0 Key  is pressed while in function mode, F0 will change from off to on or vice-versa. The top line of the LCD will display a 0 when the F0 is on and will be blank when F0 is off. F0 is most often used for reversing head lights but can be set up for other functions as well.

10.1.2 Function 1, 3, 4, 5, 6, 7, 8, 9, 10, 11, & 12



Press the button on the numeric keypad that corresponds with the function you want turn on/off. The top line of the LCD will display the numbers of the functions that are on for the active loco address. F1 is labeled with a bell icon to remind you that this is the preferred function for bell operation and F3 is labeled with a coupler icon to remind you that its preferred function is coupler operation.

10.1.3 Function 2 (F2)

Press the Horn 2 Key  on the numeric keypad. F2 is labeled with a whistle icon to remind you that this is the preferred function for whistle or horn operation.

F2 is a special non-latching function. This means that F2 can be used to control a whistle or horn sound from the decoder. It will only sound when F2 is being held down. This lets you vary the length of time that the whistle blows, just like the prototype.

To latch F2 on:

While holding the Horn 2 Key  down press the PWR Key  then release both keys simultaneously. The display will show the following:

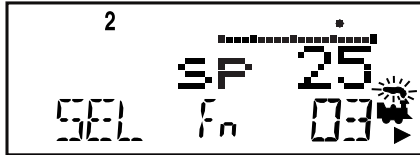

Function 2 is latched on for address 03 running on the R Throttle, the loco is running at 25% speed. Note: When F2 is latched on, the speed bar graph shows 100% to remind you that F2 is latched. The loco's speed is displayed in the text area.



To release F2, press the Horn 2 key again.

10.2 Controlling Functions On Consisted Locomotives

Even though an individual locomotive is part of a consist and you can't control its speed and direction separately from the consist, you can still control its function outputs independently as follows:

1. Press the LOCO Key  and select the address of the locomotive that is a part of consist for which you want to control functions.
2. Press the LOCO Key  again to select the loco address to your throttle. The speed value will show "cn" to remind you that you can only control functions on the loco and not its speed.
3. Use the steps described above to turn on or off the functions on the consisted loco.
4. When you are finished turning functions on or off for the consisted loco, you can release the consisted loco from your throttle in preparation for running another loco address or you can leave it selected on the throttle.

11.0 Multiple Unit Operations

Digitrax command stations offers three methods of consist control:

1. **Basic Consisting**
2. **Advanced Consisting**
3. **UniVersal Consisting (the Digitrax preferred method)**

For complete information about these methods, please consult your Digitrax Starter Set Manual.

- By definition, Digitrax always adds loco addresses to the "TOP" loco address in a consist.
- The "TOP" loco is special, in that it is the address that receives the speed & direction commands for the entire consist.
- All non TOP loco addresses added to the consist are controlled by commands sent to the "TOP" loco.
- The TOP locomotive does not have to be a physical loco on the track, it can be a phantom.
- Digitrax defines the TOP loco as the loco on the R Throttle Knob at the time when the MU add is performed.
- All loco addresses in a consist will have the same status as the TOP loco. They will all be common, in-use or idle based on the state of the TOP loco.
- Each loco within a consist maintains its original advanced 28/128 or standard 14 speed step mode setting.
- A consist can be released by one throttle and then selected and run by any other throttle.
- A consist TOP address can be dispatched and acquired on another throttle just like any other address. See Section 14.0.

11.1 Adding a Locomotive To A Consist

Radio and Infrared throttles must be plugged in to LocoNet to add loco addresses to consists.

To set up a consist using your DT400 throttle:

1. Select the loco address of the TOP loco on the R Throttle Knob.
2. Select the address of the loco you want to consist to the TOP loco on the L Throttle Knob.
3. Move the two locomotives into position. The locomotives can be headed in either direction. They can be adjacent to each other in the



train or one unit can be the mid train helper or a pusher on the end of the train.

- Before consist-ing the locos, make sure that both are traveling in the **SAME PHYSICAL DIRECTION ON THE TRACK**. (The direction indicators may or may not match, the important thing is that the locomotives are set up to move in the same direction and are not pulling against each other.)

- Press the MU Key  , the display will show the following:



the MU mode indicator on the LCD display is lit. The loco address in the L side of the display will blink to show that it is the address that will be consist-ed to the address on the R Throttle.

- The DT400 display will prompt you to press the Y + Key  to add the loco address or the N - Key  to remove the loco address from the consist controlled by the TOP loco address selected on the R Throttle. You will see the LCD alternate between the following two screens to remind you of which key to press.

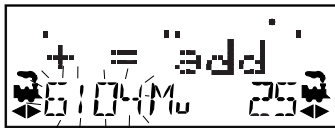

- Press the Y + Key  to add the left address to the consist.

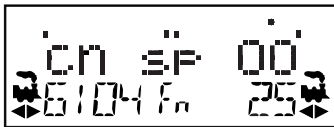

The L Throttle display shows the address of the loco that was added to the consist with a cn in the text line above it. The R Throttle display shows the address of the TOP loco address and its current % of full speed. The R Throttle is now in control of the speed & direction of both locomotives in the consist.

You can access the functions of the any loco in the consist by selecting the consist-ed loco to a throttle and using the function keystrokes outlined in Section



10.2. You will not be able to change the speed or direction of any loco that is part of a consist but, is not the TOP loco, while it is consist-ed.

Once a consist is set up & linked to the TOP locomotive, this TOP loco can be released & selected to run from either throttle on your DT400. The consist can also be selected and run on another throttle or it can be dispatched to another throttle.

11.2 Removing A Loco From A Consist

Radio & infrared throttles must be plugged into LocoNet to remove loco addresses from consists.

To remove a loco address from a consist:

- Select the loco address that you want to remove from a consist on the L Throttle.
- Press the MU Key  to enter consist mode.
- Press the N - Key  to remove the loco address from the consist.
- The L Throttle automatically becomes active with the loco you just removed from the consist. If you remove the loco from the consist while the consist is moving, the removed loco will be broken out of the consist at the same speed & direction that it was moving in the consist. You can uncouple and run the removed loco as an independent loco again!

11.3 Nested Consisting

The loco that was selected in the L Throttle to be added to the consist can itself be the "TOP" loco of another consist. When it is added to the current R Throttle "TOP" loco it will become a "nested" consist. In this case the whole nested consist is linked & itself will be part of the new consist.

The loco that is selected in the L Throttle to be removed from the consist can itself be the "TOP" loco of a nested consist that was linked into the current R Throttle "TOP" loco. In this case the whole nested consist is removed from the consist & returned to the L Throttle as a consist.

11.4 MU of Mismatched Locomotives





If all the locomotives in the consist have performance characteristics that are closely matched, you can run all the consist-ed locomotives in 128 step mode. If the units are completely mismatched (for example if you are running two different brands of locos with noticeably different characteristics), then we recommend speed matching the locos by programming Loadable Speed Tables (See your Mobile Decoder Manual more information).

12.0 Releasing An Address From A Throttle

When you are finished running a locomotive address, release it from your throttle so that it is available for other throttles to select and run.

Radio & Infrared Throttles must be plugged in to LocoNet to release an address from your throttle. You can disable this safety feature by setting your DT400's Op#3 to one of the values that allows tetherless release (See Section 24 for instructions).

To release an address from a throttle:



1. Use the throttle to make the locomotive's speed zero (this step is optional but strongly recommended).
2. While the loco's address and speed information is displayed on the LCD, press the LOCO Key  to go into select mode. This will release the address from your throttle immediately.
3. The address will begin to flash in the LCD display. Press the DISP Key  to dispatch the address on the throttle and the locomotive will be released to the system and marked as a dispatched address. The LCD in your DT400 will show SEL. See Dispatching below.
4. If you press the LOCO Key  again, the throttle will begin flashing the address you just released. You can re-select that address by pressing the LOCO Key  or you can use the throttle knobs or key pad to browse to a new address and select it instead.

12.1 Dispatching addresses or consists

Dispatching is a special feature incorporated in the LocoNet "language" to meet the needs of operators that wish to enforce a strict discipline in how operators gain access to locomotives during an operating session. Dispatching also lets you run consists with basic throttles that can't set up their own consists and run four digit addresses on basic throttles that only have two digit capability. It lets you have newcomers run trains on the layout without giving them access to the entire operation.

When you dispatch a locomotive address or consist to your LocoNet system, you make it available to be acquired by another throttle. Only one address at a time can be marked as a dispatched address in the system. The dispatched loco address is acquired by the first throttle to request it by pressing the ACQ key to select it for use on that throttle.

To dispatch a locomotive address using a the DT400

1. Press the LOCO Key  to enter address selection, browse to the address you want to dispatch.
2. Press to the DISP Key  to dispatch it to your LocoNet system, that's all there is to it!

The dispatched address can be a single locomotive address, either two digit or four digit, or a consist that was set up by the DT400. The TOP locomotive in a consist or MU can be dispatched to transfer control of the entire consist to another throttle.

Radio and infrared throttles must be plugged in to LocoNet to dispatch loco addresses.

Acquiring a "dispatched" locomotive using a UT1 or UT2

1. Set the address selector switches to address "99" then press the "ACQ" button.
2. The Status LED will light green showing that you now have control of the dispatched locomotive. (See Users Manual for UT1 or UT2 for complete instructions).

13.0 Programming and Configuration

Your DCC Decoders have many different configuration variables (CVs for short) that let you set up a different set of characteristics for each decoder installed in each locomotive.

Each of these CVs controls a characteristic of the decoder. See your decoder manual for a list of the most commonly used CVs and their meanings. Each decoder comes pre-programmed from the factory with the default settings outlined in your decoder manual. You can change your decoder's performance characteristics by changing the CV values entered in the CVs you want to change. Each of these CVs can be set up when your command station is in the programming mode or by using the Digitrax PR-1 Computer Programmer & your PC. The CVs are remembered in the decoder until it is reprogrammed to with a different CV value. Please refer to your Digitrax Mobile Decoder Manual for a complete listing of the CVs supported by each decoder.

It is a good idea to run your decoders with the default CV values that come pre programmed in your decoders until you get used to the system & what it can do for you. Once you are comfortable with running the trains, then you can begin customizing loco characteristics.

13.1 Using the DT400's key pad in Programming Mode

Before we discuss how to program decoders it is useful to explain how the DT400 behaves when you enter CV numbers and data values. CV #s 000-255 can be directly entered from the key pad when the throttle is in program mode and the indicator is displayed on the Left side of the LCD.

If you try to enter a CV Number above 255, the throttle will automatically return the display to 000.

Use the DT400 key pad to enter CV Numbers while in Programming Mode

Example: Key in CV47

Press the "4 Key"
CV# 004 is displayed

Press the "7 Key"
CV# 047 is displayed

Press the "8 Key"
CV# Returns to 000
CV#'s above 255 can't be directly entered. See below.

To Program Stationary Decoder CV's
Press the "R Reverse Key" CV#512 is displayed
Use the L throttle knob to dial in CV#'s 512-767 to program stationary decoder CV's. Press the "R reverse Key" again to return to CV range 001-255
Note: The DT400 Key pad does not work in the address range 512-767, you must use the L Throttle Knob to dial up CV Numbers in that range.

The following example shows how key pad entry works when you are entering CV Values:

Use the DT400 key pad to enter CV Values while in Programming Mode

Example: Key in a CV Value of 25

Press the "2 Key"
CV Value of 002 is displayed

Press the "5 Key"
CV Value of 025 is displayed

Press the "8 Key"
Since a CV Value of 258 is greater than the maximum CV Value allowable of 255. The DT400 displays 255. The next key-pad entry begins the sequence again.

13.2 Programming Mobile Decoder Addresses

Radio & infrared throttles must be plugged in to LocoNet to program CVs on the programming track. Ops Mode Programming can be done without plugging radio throttles in to LocoNet. IR throttles must be plugged in for Ops Mode Programming.

1. Be sure that only the loco you want to program is on the programming track. If you are using operations mode programming, the loco you want to program can be anywhere on the layout but it must have a decoder that is capable of ops mode programming installed.
2. Press the PROG Key  to enter programming mode. The DT400 will display:

Program in the text area announces that you are in programming mode.

“CVNo” on the left side indicates that configuration variable numbers will show on the left. and “dAt” on the right side indicates that CV values or data will show on the right side of the display.

The mode indicator in the center of the bottom line of the LCD shows which programming mode the throttle was using the last time it was in programming mode.

Pg=Paged mode (Digitrax Preferred Programming Mode)

Ph=Physical register mode

Pd=Direct mode

Po=Operations mode In ops mode, the left side of the display will show the address that will have programming commands directed to it. Ops mode is discussed separately in Section 15.4.

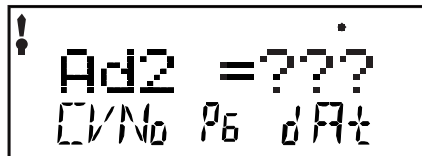

3. After a few seconds, the LCD will display the last CV and CV Value you programmed. If the display does not show Ad2=???, turn the L Throttle knob counterclockwise until you see Ad2 in the left side of the display:



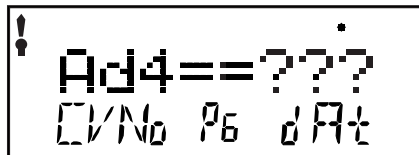

4. If you want to program a 4 digit address, press the R Throttle once to change the display to:





You can toggle between 2 & 4 digit address programming by pressing down on the R Throttle Knob.

5. Use the PROG Key  to select which programming mode you wish to use. Press the PROG Key  to toggle between Pg, Ph, Pa, & Po. Digitrax recommends using the Pg, or Paged mode for programming all Digitrax decoders when using service mode on the programming track. If you are using non-Digitrax decoders you can change to another mode if they are not capable of Paged mode.

6. To program a 2 digit address, use the R Throttle knob to dial in the address or use the keypad to enter the address and press the ENTER Key  to program the decoder. Note, when programming a 2 digit address, the decoder automatically enables 2 digit addressing.

7. To program a 4 digit address, simply enter it on the keypad or use the DT400's Throttle Knobs to dial in the 4 digit address you want to program. Use the L Throttle to dial up 1000s & 100s and the R Throttle to dial up 10s & 1s. Press the ENTER Key  to program the decoder.

8. When the ENTER Key  is pressed, the throttle will beep and display Ad2=0wr or Ad4=0wr followed by a blinking square during programming. If you programmed a 2 digit address, you can proceed to step 13 to program other CVs or you can exit programming mode and run trains.

9. If you are programming a 4 digit address, there is one more step: the throttle will display Ad4on?=y. This is prompting you to set CV29 to a value of decimal 038 or hex x26 which will enable the 4 digit address that you just programmed in 128 speed steps with analog mode conversion on. Press the Y + Key  to enable the 4 digit address and automatically set CV29 to the decimal value of 038.

10. The display will show the 4 digit address that you just programmed and enabled. If you want to continue programming additional CVs, see the next section. Press the EXIT Key  to quit programming mode and return to normal operations.

11. If your command station is a DB150 and you are using any method other than Operation mode for programming, you will need to turn track power back on after you complete programming. Press the PWR Key, then press the Y+ Key, then press the PWR Key to exit power mode. DCS100 does not require this step.

13.3 How to Program Other Configuration Variables





13.3.1 Hex Display & Decimal Display

All CV values except for 2 digit and 4 digit addresses can be displayed as either decimal or hexadecimal numbers by the DT400. When you are using the L Throttle knob to browse through CVs 002 through 255, you will use the R Throttle knob to set the CV value you want to program. By default, the DT400

displays the CV values as decimal numbers 000-255 (nnn). To view the numbers as hexadecimal simply press the R throttle knob and you will see the CV value change to the hex equivalent of the decimal. Hex numbers are displayed as xnn. For example the decimal value of 006=the hex value x06. The decimal value 011= x0B. The ability to toggle between decimal and hex effectively gives you an instant conversion table.

13.3.2 Programming CVs Other Than Addresses

There are many different CVs that have been defined to handle many characteristics you might want to use for your locomotives. Your decoder manual has a complete listing of CVs that are available in specific decoders, what they do and suggested values for each CV.

1. Place the decoder equipped locomotive you want to program on the programming track. If you are using operations mode programming, the loco you want to program can be anywhere on the layout but it must have a decoder that is capable of ops mode programming installed.
2. Enter Program Mode by pressing the PROG Key  to enter programming mode. The display will show the last CV and CV Value you programmed.
3. Select the programming mode you wish to use by pressing the PROG Key  until the method you want appears in the Mode Indicator.
4. Turn the L Throttle to begin selection of the CV# you want to program. You can dial it up using the L Throttle or you can use the keypad to enter the number. You will see the  icon displayed on the left of the DT400 display when you are entering CV Numbers. You can select CV#s 01 through 255.
5. Enter the CV value you want to program using the numeric keypad or turn the R Throttle to dial up the CV value you want to enter. You will see the  icon displayed on the right of the DT400 display when you are entering CV Values. CV values are displayed as decimal numbers by default.

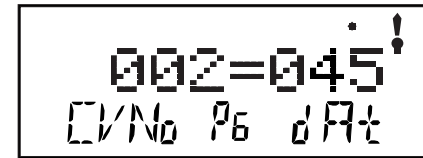

Use Paged Mode (Pg) to Program CV02-Start Voltage



To a CV value (dAt) of 045 (decimal)

The  symbol indicates that values entered by turning the R throttle knob or entering numbers from the keypad will appear in this side of the DT400's display.

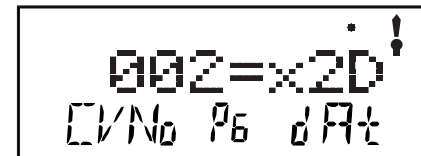
Remember that you can click the R Throttle to toggle the CV value display between decimal and hex as shown below.



Press the R Throttle Knob to display CV value of 045 decimal as x2D hex

6. To access CVs 513 and above for stationary decoders simply press the R Reverse Key . In this range of addresses, use the L throttle knob to dial up the stationary decoder CV# and the R throttle to dial up the stationary decoder CV value.
7. Press the ENTER Key  to program the selected CV value into the selected CV number.
8. Press the EXIT Key  to quit programming mode and return to normal operations.

You can program as many CVs and their values as you want in a session.

When you are finished, press Press the EXIT Key  to quit programming mode and return to normal operations.

9. If your command station is a DB150 and you are using any method other than Operation mode for programming, you will need to turn track power back on after you complete programming. Press the PWR Key, then press the Y+ Key, then press the PWR Key to exit power mode. DCS100 does not require this step.

13.4 Operations Mode Programming



Operations mode programming lets you program CVs in DCC locomotives equipped with Extended Packet Format decoders while they are on the main-line. A typical use for Ops mode programming would be to change the acceleration rate (CV03) or the deceleration rate (CV04) of your locomotives to simulate the weight and braking capability of the train to compensate for changing the number of cars or power units on a train.

Your DT400 can use ops mode programming to change the CV value in ANY CV, including 2 digit and 4 digit addresses.

Ops mode programming can be performed by any DT400 at any time since the throttles are not competing for usage of the single programming track.



Radio throttles do not need to be plugged in to LocoNet during Ops Mode Programming. When you enter programming mode with a radio throttle, Ops mode is the only programming mode that will be available unless you plug in to LocoNet. IR throttles must be plugged in for Ops Mode.

How to use Operations Mode Programming

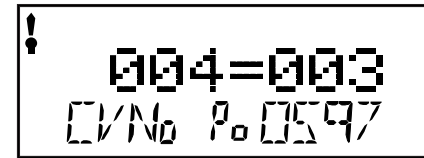
1. Select the DCC loco address that you want to program on either the L or R Throttle. Be sure that the address you want to program is the active throttle, the one with the blinking smoke when you enter programming mode.
2. Enter Program Mode by pressing the PROG Key  to enter programming mode. The display will show the last CV and CV Value you programmed.
3. Select operations mode programming mode by pressing the PROG Key  until the “Po” appears in the Mode Indicator area of the LCD. If you are using an infrared or radio throttle, the display will automatically show Po. The DT400 display will show the address that was selected on the active throttle in the right side of the bottom line of the display. This is the address that you are preparing to program.
4. Use the L Throttle knob to dial up the CV you want to modify. Use the R Throttle knob to dial up the CV value you wish to program for the CV.



This display shows a typical operations mode programming screen:

1. **Po** in the Mode Indicator Area shows that we are in Operations Mode Programming
 2. **0597**, the address being programmed appears in the lower right corner.
 3. **CV Number 004** (deceleration)
 4. **CV Value of 003** (a moderate amount of deceleration)
 5. The **!** symbol indicates that the left side of the display is active meaning that any key pad entry made will show in the CVNo area of the display.
5. Press the ENTER Key  to program the selected CV value into the selected CV number.
 6. Press the EXIT Key  to quit programming mode and return to normal operations.
- You can program as many CVs and their values as you want in a session.
- When you are finished, press Press the EXIT Key  to quit programming mode and return to normal operations.
7. With ops mode programming, the command station does not turn off track power. If you are using a DB150, you do not need to turn track power back on after programming with ops mode like you do with service mode programming.

13.5 Busy or Fail Message



If you get a “Busy” message in response to any programming task, the system is temporarily busy and you will have to try the task again until you get a “Good” response.

If you get a “Fail” message in response to any programming task, check to be sure that there is a loco on the programming track and that the programming track is powered.

13.5 Reading Back CV Values Programmed

Your DCS100 and DT400 together can read back the configuration variable values programmed into your decoders. Since you must use the programming track for this, infrared and radio throttles must be plugged in to LocoNet to read back CV & their values. Systems with a DB150 command station are not able to read back CV Values programmed into decoders.

To read back CV values:

1. Place the decoder equipped locomotive you want to program on the programming track. You can also do an ops mode read back with Digitrax transponding decoders if you have a LocoNet device that allows ops mode read back plugged in to LocoNet.
2. Enter Program Mode by pressing the PROG Key  to enter programming mode. The display will show the last CV and CV Value you programmed.
3. Select the programming mode you wish to use by pressing the PROG Key  until the method you want appears in the Mode Indicator.

You can read back in PG, PH, Pd, or Po modes with the following restrictions:

PG Paged Mode no restrictions

PH Physical Register Mode can only read CV01-CV08.





You should not rely on values in the display for CVs above 08 when reading back in physical register mode.

Pd Direct Mode no restrictions

Po Operations Mode readback can only be used with Digitrax decoders that are capable of ops mode read back when there is a device attached to LocoNet that supports ops mode read back. Digitrax transponding decoders and DCS100 would allow ops mode read-back.

4. **To read back the CV value programmed for the two digit address (CV01)**, use the L Throttle knob to dial up Ad02 on the left side of the text area and then press the DISP Key . The text area will show Ad2 =rd followed by a flashing box. When the read back is finished, the CV value (the 2 digit address) will be displayed on the right side of the text area.
5. **To read back the four digit address that is programmed into the decoder** use the L Throttle knob to dial up Ad02 on the left side of the text area, then press the R throttle knob to change to Ad4. The

text area of the display will show Ad4=???? (disregard any value that appears at this time). Press the DISP Key  and the display will change to Ad4=8rd followed by the flashing box. When the read back is finished the 4 digit address will be displayed on the right side of the text area.

6. **To read back any other CV** start at AD2=??? (Use the L Throttle knob to dial in Ad2 on the left side of the display or if you were in four digit addressing, press the R throttle knob once). Use the L Throttle knob to dial up the CV you want to read back or use the numeric keypad to enter the CV Number. Press the DISP Key  the display will show the CV number=rd followed by the flashing box. When the read back is finished, the CV value for that CV will be displayed in the Right side of the text area.
 7. Once you have read back any CV, you can change its value by dialing in the CV value you want to program and pressing the ENTER Key .
 8. Press the EXIT Key  to quit programming mode and return to normal operations (Fn Mode).
- You can read back and re-program as many CVs and their values as you want in a session. When you are finished, press Press the EXIT Key  to quit programming mode and return to normal operations.
9. If your command station is a DB150 and you are using any method other than Operation mode for programming, you will need to turn track power back on after you complete programming. Press the PWR Key, then press the Y+ Key, then press the PWR Key to exit power mode. DCS100 does not require this step.

14.0 How Your Command Station Manages Addresses

Your command station has a finite number of “slots” available in its memory. Once the slots available in your command station are full, the system will display the “slot=max” or “FF” message to let you know that you need to release some locos if you want to select and run others. Your command station manual details how many slots your command station can handle. It also explains how your command station handles purging of addresses from the system to allow for more addresses to be selected and run.

Please check your starter set manual for a complete discussion of the purging strategy used by your command station.

15.0 Decoder Status

The command station assigns status codes to each locomotive address in the system. Addresses are either selectable or not selectable. Decoders are not selectable if they are in-use on another throttle or if they are part of a consist. If you try to select an in-use address, you will be prompted to “Steal” the address. If you select a decoder that is part of a consist, you will be able to send function commands but you won’t be able to control its speed or direction. The text line in the DT400 display will show “top”, “cn” or “mid” if the address is part of a consist, otherwise it will show “stat”. This display is followed by the status code for one of the following modes of operation.

Table IV: Decoder Status Codes

Display	Meaning
28	28 Speed Step Mode
tri	Motorola Trinary Format Mode
14	14 Speed Step Mode
128	128 Speed Step Mode Digitrax Preferred Mode
*28	FX 28 speed step-enable advanced consist mode
x01	Reserved, Do not use
x02	Reserved, Do not use
*128	FX 128 speed step-enable advanced consist mode

Status editing is used most often when you are running non-Digitrax decoders that do not have 128 speed step capabilities. If you can’t get a non-Digitrax decoder to work on your layout and you are sure you are using the correct address for the decoder, you probably need to status edit it to run in 14 or 28 speed step mode.

15.1 Status Editing a Decoder



To Change the Status of a Decoder

1. Press the LOCO Key  to enter address selection mode, the LCD screen will begin flashing the address on the active throttle and will display “Sel Loco” in the text area to prompt you to select an address. Lo will also be flashing.
2. When you use the throttle knobs or key pad to enter the address of the locomotive you want to select, the display will show the current status of the decoder. To display the status code of the loco address

that is flashing in the display when you enter selection mode, just turn the throttle knob up one address and then back to the original address and the status code will display on the LCD.

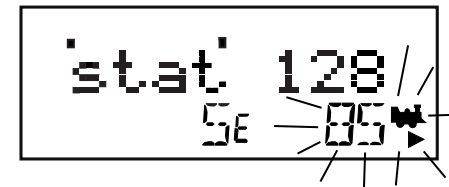
3. To change the status of the decoder simply press the EDIT Key  the flashing Lo will change to SE and the current status code of the address will be displayed on the LCD. Use either throttle knob or press the EDIT Key to scroll through the status codes shown in the table above.



4. Once the status code you want to use for the address is displayed in the text area of LCD, press the ENTER Key  to change the status code of the locomotive and to select it to run on the active throttle knob.
5. If the loco address is in-use on another throttle or in a consist when you press the ENTER Key  to complete the status edit process and select the loco on the active throttle, the DT400 will prompt you to Steal=Y. If you want to steal the address, press the Y + Key  to complete the status edit. If the loco is part of a consist, it will not be selected and will remain part of the consist when the status is edited.



15.2 Note for Non-Digitrax Decoder Users

If you have a decoder that does not have advanced 28/128 speed step mode available, you must “status edit” that locomotive to standard 14 speed step mode before running it with your Digitrax system. Changing the decoder’s status will cause the system to handle this decoder as a 14 speed decoder. Status editing does not reprogram anything in the decoder.

16.0 Sw (Switch) Mode

Switch mode is used for sending commands to accessory decoders and for changing option switches in your LocoNet system. The most common use of switch mode is for operating turnouts.

To change the position of a switch or turnout

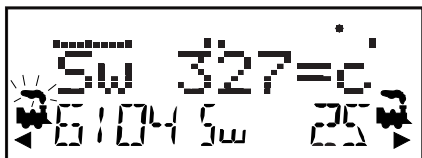

1. Press the SWCH key  to enter switch mode. When you enter Switch mode, the throttle knobs & direction keys will continue to control the loco addresses running on the throttle. Loco speed will be displayed on the bar graph and loco direction will be displayed on the direction indicators for each throttle. The numeric keypad will be used to enter switch numbers and the OPTN t  and CLOC c  Keys are used to tell the switch in which direction it should operate.
2. The last switch decoder address selected by your throttle is displayed on the text line followed by a “c” or a “t”.
3. The LCD indicates the switch position using the c or t as follows:
 - “t” indicates that the switch is “thrown” (for a turnout, the diverging route is set)
 - “c” indicates that the switch is “closed” (for a turnout, the mainline route is set)

If the “t” or “c” indicator is flashing it means that the LocoNet Command Station does not know the current switch position. A steady “t” or “c” indicates that the command station knows the position of the switch.





This LCD shows a DT400 in Switch Mode

1. **Sw**=Switch Mode
 2. **Switch 327** is selected and is in the c (closed) position. .
 3. Address **6104 is active** (blinking smoke) on the L throttle
 4. Address 6104 is running at **50% speed** (bar graph) in the reverse direction.
 5. Address 25 is running on the R throttle at 0% speed in the forward direction.
4. Use the numeric keypad to enter the switch address you want to change
 5. Once the desired switch address appears in the text area of the throttle, you will see either “c” or “t” on the right side of the = sign in the display. If the “c” or “t” is flashing, the command station does not

know the position for this turnout. Press the OPTN t Key  to move the switch to the “thrown” position **OR** the CLOC c Key  to move it to the “closed” position.

6. If the switch you selected is a turnout connected to an accessory decoder, it will change position from closed to thrown or vice-versa. If the switch you selected is an op switch setting for your command station, the software switch inside the command station will be changed.
7. After commanding the switch “closed” or “thrown” the switch position display will stop flashing, since the command station now knows the current switch position.

Note that the accessory decoders in the system are accessible to all throttles or control devices with switch control capabilities & are not reserved in-use to a single throttle like locomotive decoders.

8. When you have finished your Sw (switch) operations you can return to Fn (Normal Operating Mode) by pressing the EXIT Key  or the FUNC Key .
9. The next time you enter Sw mode , the DT400 will remember where you left off & start at the last switch address & position you accessed.

17.0 Edit Fast Clock, Routes, etc.

The DT400 throttle can edit system functions like the fast clock and routes. Both of these features can be enabled or disabled by your command station. Digitrax command stations ship with fast clock enabled and routes disabled.

17.1 Fast Clock Basics

Many operators use a fast clock during operating sessions to simulate prototypical operations. Traditionally, this clock is on the wall and is set up to run at a faster than normal rate. LocoNet has its own networked fast clock for all Digitrax throttles connected to your system.

The fast clock display is a 4 digit 12 or 24 Hour format clock. To display the

fast clock simply press the CLOC c Key . The fast clock display will remain active while you are running trains until you initiate another throttle task such as loco address selection, programming, MU, Switch mode, etc. To stop displaying the fast clock and return to the default DT400 display, press the

CLOC c Key  again. This is the display you will see when the fast clock option is set to display.

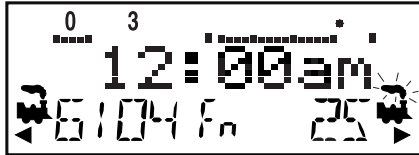

Display with FastClock showing 12:00am

1. Address 6104 running at 25% speed on the Left throttle in the reverse direction.
2. Address 25 running at 75% speed on the Right throttle in the forward direction. Blinking smoke shows that Address 25 is currently active in the display so its active functions, 0 & 3 are displayed on the top line of the LCD.

Any DT series throttle (including your DT400) that is plugged in to your LocoNet system will update its fast clock time and rate to be synchronized to the rest of the system a couple of seconds after it is connected to LocoNet.

Each DT400 can be set up with an alarm. When the current fast clock time matches the private alarm time set in any DT400, then that DT400 will beep and flash the message “Alarm” to indicate that the alarm time has elapsed.

The fast clock rate for the fast clock is user selectable from 1:1 to 100:1 in steps of 1. The most popular range of values is 4:1 to 8:1.

17.2 Stop the Fast Clock





Setting the clock rate to 00 will stop the fast clock for the entire system at the currently displayed time. Fast time will re-start when a new non-zero rate value is set.

The current fast clock time, fast clock rate and the DT400 alarm time can be changed by using the Edit mode.

**17.3 Edit Fast Clock Time, Rate & Alarm
To Edit Fast Clock Time, Rate & Alarm**

Note: DT400 must be plugged in to LocoNet to edit the fast clock settings.

1. From Fn mode, press the EDIT Key  to change to Edit Mode mode.

2. Press the EDIT Key  to scroll through the different things you can edit.
3. The first time you press the EDIT Key, the mode indicator in the center of the bottom row of the display will show Ec (Edit Clock Mode) and the text area will show a 12 or 24 hour time. See Section 23.3.2 for setting the clock for 12 or 24 hour operation.
4. Use the L & R Throttle knobs to dial up the “current” time. Use the L Throttle for hours and the R Throttle for minutes. You can only move time forward. Press the EDIT Key  again to set the time and move on to edit the fast clock rate.
5. When you press the EDIT Key the second time, the mode indicator will display Ef (Edit Fast Rate) and the text will show Rate=nnn where nnn is the clock rate. Use the throttle knobs to dial up a clock rate that is between 000 & 120 (the throttle will let you dial up to 255 in this case but values above 120 have no meaning to the system). Press the EDIT Key  again to set the fast clock rate and move on to edit the throttle alarm time.
6. Once the time and fast clock rate are set, the mode indicator will display Ea (Edit Alarm) and the text will show a 12 or 24 hour time. Use the throttle knobs to dial up the alarm time. Press the EDIT Key  again to set the fast clock alarm. NOTE: The fast clock alarm can’t be turned off.
7. Once the time, fast clock rate and alarm are set, you will automatically return to Fn Mode unless your system is enabled for other types of editing such as routes. If you are set up for routes, the clock editing screens will be followed by Er for editing routes as described below. To exit Edit mode at any time simply press the EXIT Key .

17.4 Route Basics

You can use your DT400 with a DCS100 to set up routes that are triggered by operating a single turnout address to make it either c(closed) or t(thrown). Setting up and operating routes is similar to consisting locomotives because you can cause more than one unit to operate based on a single command sent to the system. We call the turnout address that other turnout addresses are “consisted” to the TOP address. To operate a route, use Sw (Switch) mode to select the TOP turnout address in the route and move it to either closed or thrown to initiate the route you have previously set up in your route list. The TOP turnout address does not need to be physically present on the layout, it can be a “phantom” turnout address.

The DCS100 supports up to 32 routes. Each route consists of a list that contains a TOP turnout address and its position (c or t) and up to 7 other turnout addresses and their positions. Routes are stored in the DCS100's memory and can be operated by any throttle in the system that can send switch commands. Each of these 32 routes is operated by setting the TOP turnout address to the position saved in the route list. When a route is triggered, a route can include a switch that is the Top of another route and all the entries in the second route will be added to the string of turnout commands the initial route request generates. The second route called is a "nested" route.

From the initial route you can "nest" up to 3 levels deep. Note that a route that itself does not contain another Top switch (i.e., another route) will not increase the nest depth. Knowing this, you can assemble up to 120 switch commands in a single route if you are careful when you set up your nesting.

If the DCS100 determines that you have exceeded these limits, it will beep 5 times to alert you to the problem. Note that if a route contains the same switch command more than once and this causes the route to "loop back" on itself, this will also generate a 5 beep route error indication and no switch commands will be issued to the layout. In this case you will need to edit the route and correct the errors in the list before trying the command again.

17.4.1 Enabling Routes

Before you can use routes in the DCS100 you must set the DCS100's OpSw #26 to "closed." See your DCS100 manual for instructions for changing OpSws

You can erase all current routes in the DCS100 by setting OpSw 37 to "closed."

17.4.2 DS54 Cascaded Routes

Because the DS54 can also generate cascade switch message commands, it can be used to augment the DS54's "local route" capability with any LocoNet route that is in the system. Even if you do not use the internal or local routes of the DS54, you can trigger up to 8 different route requests to the system from small push buttons attached to the DS54. Remember to select the correct Cascade control value from the DS54 manual so that the "thrown" or "closed" state matches that of the Top turnout address of the route you want to trigger. Also be sure to connect the DS54 to LocoNet by the black 6 pin RJ12 jack so it can "talk" to LocoNet!

17.5 Edit Routes

To go to the Edit Routes (Er) mode you must pass through the clock editor:

1. Start in Fn mode. Press the EDIT Key  to enter Edit Mode. Press the EDIT Key again to enter Ec (Edit Clock) mode. Press the EDIT Key again to enter EF (Edit Fast Rate) mode. Press the EDIT Key again to enter EA (Edit Alarm) mode. Press the EDIT Key again to enter Er (Edit Routes) mode.

The DT400's display will show the following screen when you enter the Edit Routes mode.

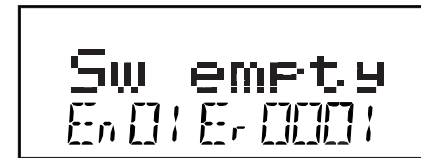



This display shows Er (Edit Routes) in the Mode Indicator area on the bottom row to let you know you are in Edit Routes mode. The right side of the bottom row shows which route you are working with. This can be any number from 01 through 32. The left side of the bottom row of the display shows which entry within the route you are working with. The En (entry) number can be any number from 01 through 08. En01 is the TOP or controlling turnout address. The position, c or t, that you set for this turnout address is the one that will operate the route. The text area shows "Sw empty" to let you know that nothing has been entered for Entry 01, Route 01.

2. Use the R Throttle knob to dial up the Route number you want to work with. The bottom right display will show the route number. The DT400 will allow you to dial up above route 32 but please DO NOT USE route numbers outside the range of 01-32.
3. Use the L Throttle knob to dial up the Entry number within the chosen route that you wish to work with. The bottom left display will show the entry number.







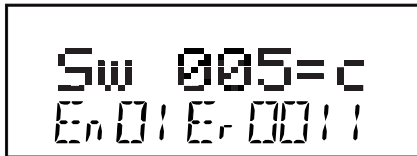

This display shows Entry 01, Route 11 as empty.

4. Press the ENTER Key  and “Sw” in the text area will begin to flash, use the Throttle knobs to dial up the turnout address you want to add to the route. Use the L Throttle for 100s and the R Throttle Knob for 10s & 1s. Once you make changes to the turnout address number or the position of that address, the entire text area will begin to flash. The key pad is not active during this throttle task even though some keys may change the display.
5. When the turnout address you want is on the screen use the OPTN t Key  to set the turnout to t (thrown) or the CLOC c Key  to set the turnout to c (closed).



This display shows Entry 01, Route 11 with turnout address 005 set for closed. In this case address 005 is the TOP address for this route because it is Entry 01 for the Route.

6. If you wish to make no changes to the route and entry selected, simply press the BACK Key  or either of the Throttle knobs to exit turnout address/position editing and return to selecting a different route/entry number.
7. Once your selection is complete, press the ENTER Key  to save the turnout address in the position selected into the route.
8. Continue entering route entries in this manner until your route is complete. You can toggle back and forth between selecting route and entry numbers and entering turnout addresses and positions by pressing either Throttle knob or the BACK Key .

9. Once you have finished editing routes, press the EXIT Key  to exit the Er (Edit Routes) mode and return to Fn (Normal Operating) mode.
10. To operate the routes that you have set up, simply press the SWCH Key , key in or dial up the TOP turnout address for the route and press the OPTN t Key  or the CLOC c Key  to issue the appropriate t (thrown) or c (closed) command. When you select the TOP turnout address in a route and the position (c or t) you issue matches the position that is stored in the route, the route will operate. If you select the opposite position from that stored as the route, the TOP turnout address will change to that position & the route will not operate.

See your Chief II Manual for additional information about setting up routes and how the DCS100 handles them.

18.0 FIND Key & Digitrax Transponding

On layouts set up for Digitrax transponding with transponders in locos and rolling stock and transponder receivers installed on the layout, the DT400's FIND Key is used to turn on the find command. This lets you see the zone location of transponders on the layout in your throttle display.

To use the FIND Command:

1. The layout must have Digitrax transponder receivers (BDL16 & RX4s) installed and configured.
2. The loco or other rolling stock that you want to track must have a transponder installed. This can be either a transponding decoder or a stand alone transponder.
3. Select the address of the transponder you want to track on the active throttle on your DT400 (the one with the flashing smoke icon). Find can only be active for one address at a time.
4. Press the FIND Key , the display will show a screen similar to one of the following examples:

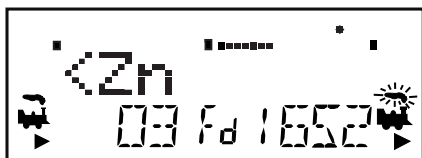

This example shows a DT400 in FIND mode for address 03 selected on the L Throttle. The system is not able to find address 03 so there is no display after the <Zn. Either the loco or rolling stock with address 03 is not present on the layout or it does not have a transponder or it is located in a zone that does not have a transponder receiver.

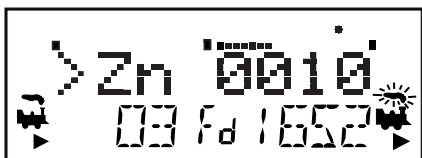



This example shows a DT400 in FIND mode for address 1652 selected on the R Throttle. The system sees address 1652 in Zone 0010. When address 1652 moves to another Zone, the display will automatically update to show the new Zone location.

- Find will remain active until you press the FIND Key again to disable find mode.

19.0 Shut Down and Resume Procedures

Some users prefer to “dispatch” or release all addresses active in their system before shutting down. This can prevent unexpected results when you power up the layout again. This procedure is covered in detail in Section 12.1.

- Turn track power off: Press the PWR Key  followed by the N- Key , the Track Power Indicator on the DT400 and the Track Status Indicator on your command station will go off.
- Move the command station’s “MODE” switch to the “SLEEP” position .
- Turn off the power supply to the system.

The power to the command station can be left on all the time if desired. In “sleep” mode, the command station consumes very little energy. In this state the command station provides keep alive power to all throttles that are connected to LocoNet.

20.0 Troubleshooting Throttle Problems



See your Starter Set Manual for general system troubleshooting tips.



20.1 I’m lost!

If your DT400 display isn’t showing you what you expect based on the manual,



press the EXIT Key  to return to normal operating mode-Fn. Then try the throttle task again.

20.2 Emergency Stop

If the layout starts to “get away” on you, either PRESS the PWR Key  followed by the N- Key  or, turn the track power to “SLEEP” on the command station. Either way, the layout will stop to give you a chance to regain your composure. To resume operations where you left off, press the PWR Key

 followed by the Y+ Key .

20.3 Nothing is responding

Is track power turned on? Is your throttle in Idle or stopped and displaying a flashing track power indicator in the LCD? Press the PWR Key  followed by the Y+ Key . You should see the track power indicator on the DT400 and on your command station come on.

20.4 Can’t select a loco on my throttle

Is the loco in use by another throttle (did the throttle ask you “STEAL=Y?”).

Is the loco part of a consist (do you see a cn in the display when you try to select it)?

Do the settings in CV29, the configuration register, match the command station output? If your decoder is a 14 step decoder running on any Digitrax system using factory defaults, status editing will be needed for that decoder.

Have you reset any CVs since the last time you ran the loco? If so, go back and change them to their default CV values and then try to run the loco. It is possible to set acceleration so high that it will take 10 minutes for the loco to start moving.

Does your throttle say “slot=max” ? This means that the system’s capacity to handle operating locos is full. The DCS100 can run up to 22 or 120 addresses at the same time. If you have the “slot=max” message, be sure that all locos that are not running are released from throttles or set DCS100 OpSw 44 to closed to increase the number of addresses to 120. The DCS100 command station that comes with Empire Builder II & Genesis II sets have a system limit of 22 addresses.

Was the loco running normally just before it stopped? If the decoder is very warm it may be in thermal shutdown. Let it cool off and see if it starts again. Also check for localized track problems.

Are there burn marks on the decoder? You’ll need to send it in for repair! If all else fails, reprogram the decoder address and reset CVs to default values.

20.5 “Strange” Locomotive Lights

If you can’t control the operation of the lights in your locomotive with the DT400 (in default 128, or 28 speed step mode), be sure that the decoder is programmed in advanced 28 speed step mode.

Do this by programming CV29 with a decimal value of 06. See your Decoder Manual for more information about programming decoders.

21.0 Tetherless Operation of DT400/R

All DT400s are “InfraReady.” This means that your DT400 comes with IR LEDs that will send infrared signals to the layout. To use this InfraReady capability, you just need to install one or more infrared receivers on your layout.

DT400R is a radio equipped throttle. To use your DT400R as a radio throttle, you will need to install a radio receiver on your layout.

A 9 volt battery must be used to power the DT400/R for tetherless operation. Using DT400/R as a tetherless throttle is easy:

1. For Infrared operation, plug in at least one Digitrax IR receiver (UR90 or UR91) to your working LocoNet. Because infrared signals are line of sight, more than one receiver may be necessary for

optimal performance in your layout room. See your starter set manual for more information about installing UR90 and/or UR91s on your layout.

2. For Radio operation, plug in at least one Digitrax Radio receiver UR91 to your working LocoNet. Most layouts only need one UR91.
3. Install a 9 volt battery in your DT400/R. See Section 22 for battery installation information.
4. Plug your DT400/R in to LocoNet and it will verify that at least one infrared and/or radio receiver is connected to LocoNet. The throttle will display either rA or Ir (depending on whether it finds an infrared or radio receiver first) followed by the current LocoNet ID. This example shows that the DT400/R has detected a radio receiver and that the current LocoNet ID is 01. The throttle has loco addresses 03 & 1280 selected.

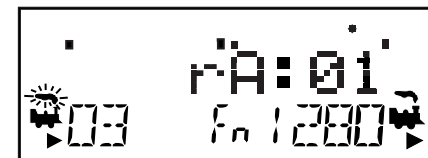

5. The DT400/R will use the **LocoNet ID** of the LocoNet it was plugged in to and will begin to operate as an IR throttle when you unplug it from LocoNet. When you unplug from LocoNet, the tetherless indicator will come on and the tetherless message will display for a few seconds indicating whether the throttle is running as Ir (infrared) or rA (radio). It will also display the LocoNet ID that the throttle is logged on to.
6. When you single click or turn either throttle knob to activate it, the DT400 will show the normal operating mode Fn display with the tetherless indicator lit.

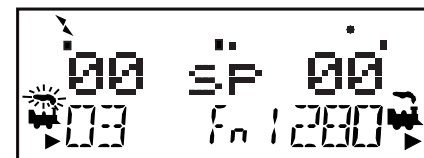

If an untethered DT400/R, operating as a tetherless throttle, detects no user throttle activity for about 3 minutes it will enter power save mode. The display will show:



The throttle may flash the normal Fn Mode screen about every 60 seconds. This happens when the throttle “pings” the system to let the command station know that it is still part of the system. This keeps the system from releasing that locomotive back to the system and making it available to be selected by another throttle.



Press and hold the PWR button to bring the throttle out of power save mode without making any changes to throttle settings. Any key strokes or movement of the throttle knobs will also bring the DT400/R out of power save and return to the normal Fn mode screen.

Fast clock caution: If you use power save mode, the DT400/R’s local fast clock copy will deviate from the LocoNet system clock. The fast clock will re-synchronize with your LocoNet system fast clock when it is plugged in again.

21.1 LocoNet ID Change

Your DT400/R will log on to the LocoNet ID offered by compatible infrared or radio receiver it sees when plugged in to LocoNet. The default LocoNet ID is 00. It may be necessary to change the LocoNet ID if more than one club is operating in close proximity at a train show so that the commands sent by one club will not interfere with the commands sent by other clubs.

To change a LocoNet ID:

1. Disconnect a DT400/R from the LocoNet for which you want to change the LocoNet ID.
2. Press and hold down the EDIT Key  on the DT400/R and then plug it back in to LocoNet. Release the EDIT Key  after plugging in the throttle.
3. The DT400/R will display E1 in the Mode Indicator and the current LocoNet ID “Ir:0n” or “rA:0n”, where “n” is the current LocoNet ID. Use the R throttle knob to change the LocoNet ID. You can set the LocoNet ID to be any number from 0 to 7.

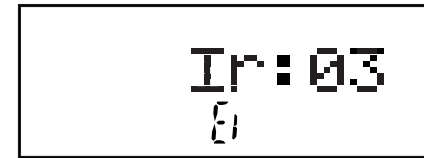

This display shows a DT400 that has found an Infrared receiver on LocoNet with a current LocoNet ID of 03. The DT400 is ready to Edit the LocoNet ID. Other characters may be displayed on the screen at this time depending on the current throttle state.

4. Press ENTER Key  to set the system to the new LocoNet ID.
5. The DT400/R used to change the LocoNet ID will automatically log on to the new LocoNet ID.
6. **Unplug and reconnect any other DT series infrared or radio throttles that will be used on this system so that they can log on to the new LocoNet ID number and be able to operate on the system.**

If you add a new UR90 or UR91 to the system and are using a LocoNet ID other than the initial default value of 0, you must to re-synchronize the IDs in all the UR90s and UR91s by setting the LocoNet ID as described above. If you are operating in an area where more than one LocoNet systems is operating nearby, be sure to coordinate with other layouts so that each one has its own unique LocoNet ID before beginning operations.

21.2 Tetherless Operation

Selecting a Locomotive-Safety Selection

While tetherless, the DT400/R operates as a one-way transmitter. The DT400/R must be plugged into LocoNet to select an available locomotive address. After an address is selected on your DT400/R, you can unplug from LocoNet and run the selected addresses with infrared or radio. The throttle will automatically convert to infrared or radio operation for all speed, direction, function, operations mode programming, and switch commands.

Digitrax uses a safety selection procedure that requires throttles be plugged in to LocoNet to select a loco address to run. This is an important operational safety feature. Digitrax chose not to allow one way address selection to prevent multiple operators from being able to select and send commands to the same addresses at the same time. Having multiple operators sending com-

mands to the same address can result in serious problems in an operating session because locos can appear to be out of control.

Releasing a Locomotive

Two options are available for tetherless release. These options are set by DT400 Option #3, see Section 23.2.2 for instructions.

No tetherless release allowed: if the LOCO Key  is pressed while the DT400/R is running in tetherless mode, the addresses selected will not be released unless the throttle is plugged in to LocoNet. This is the factory default.

Tetherless release allowed: if the LOCO Key  is pressed while the DT400/R is running in tetherless mode, the address selected on that side of the throttle will be released immediately and that throttle will become inactive. To re-select this loco address plug your DT400/R in to LocoNet and select the loco address on the throttle.



Multiple Unit Operations

Consists must be assembled and broken up while the DT400/R is plugged in to LocoNet. MU operations are locked out while the DT400/R is running tetherless. Once a consist is assembled, it can be operated normally using the DT400/R in tetherless mode.

Programming

Ops mode programming is the only programming method that will work while the DT400R is operating as a radio throttle. If you press the PROG Key  to enter programming mode, the DT400R running as tetherless will default to the Po mode (ops mode programming). The DT400R must be connected to LocoNet to use service mode programming and access any of the other programming modes available.

Switch Mode

The DT400/R will operate in “Switch” Mode while tetherless. It can operate turnouts and routes using the OPTN t  & CLOC c  Keys in the normal manner.

Ballistic Tracking

While running tetherless, ballistic tracking will feel slightly different than while connected to LocoNet.



Fast Clock

When using the fast clock option, the DT400/R will keep track of and display fast time based on the last synchronized system fast time when the DT400/R was connected to LocoNet. If the fast time is edited by another throttle connected to LocoNet, the DT400/R will not see this change until it is plugged into LocoNet at which time its display will be updated.



21.2.1 Control Lock

While the DT400/R is being used tetherless, there are occasions when you may want to disable the throttle’s controls to prevent accidental commands being sent to the railroad. For example, your train is in a siding waiting for another train to pass. You put your throttle in your pocket and go take a break. By locking the throttle controls, you will not be able to accidentally start your train if you bump your throttle knob or press the Y + Key .

To lock the controls on your DT400

1. Press both the Y +  and the N -  Keys at the same time.
When you are locking the keyboard be sure to press both the Y+ & N- Keys AT THE SAME TIME to avoid sending a speed command to the active loco.
2. The throttle will display “Lock=+&-” in the display and none of the controls will function until you unlock them.

To un-lock the controls with “Lock =+&-” on the display:

1. Press both the Y +  and the N -  Keys at the same time again. This will return the throttle to normal operation.
2. Plugging the throttle into LocoNet will also unlock the throttle.

22.0 DT400 Battery

22.1 Battery Installation

For normal tethered operation, the DT400 does not need a battery. If you want to use your DT400/R as an infrared or radio throttle, you must install a 9 volt battery. When you install the battery, the throttle will report the battery voltage and then display Idle. Once you plug in to LocoNet, DT400s will begin operating infrared and DT400Rs will begin operating as radio throttles.

We recommend that you remove the battery from throttle if it is unplugged from the system to conserve battery life.

Batteries can be stored inside the DT400/R by removing the battery and

putting it back in the battery compartment with the polarity reversed.

22.2 Low Power Indicator

While it is running as a tetherless throttle, the DT400/R automatically checks the power available to the throttle each time a battery is inserted and each time it is plugged into or unplugged from LocoNet. The power from the battery or from LocoNet will be displayed in the text area of the throttle briefly each time the throttle is plugged in or is unplugged from LocoNet.

When you plug in to LocoNet the number displayed will be the power provided by LocoNet. This value will be between 9 & 15 volts. Other characters will also be displayed in the LCD depending on which locos are selected and their speed and direction.

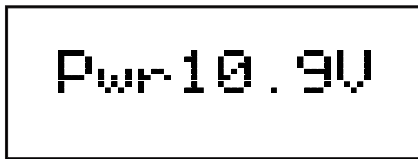

When you insert a battery or unplug from LocoNet, the value displayed will be the battery power. When this number is less than 6.2 V you may want to consider changing the battery. The DT400/R will still continue to

operate reliably for an extended period of time depending on the type battery is in use. 9 volt alkaline batteries are nearing the end of their life at 6.8 volts, but 7.2 volt NiCad rechargeable batteries may still have lots of life remaining. Experience will determine how long your DT400/R will operate with the batteries you are using.

Diagram 4: DT400/R Battery Installation

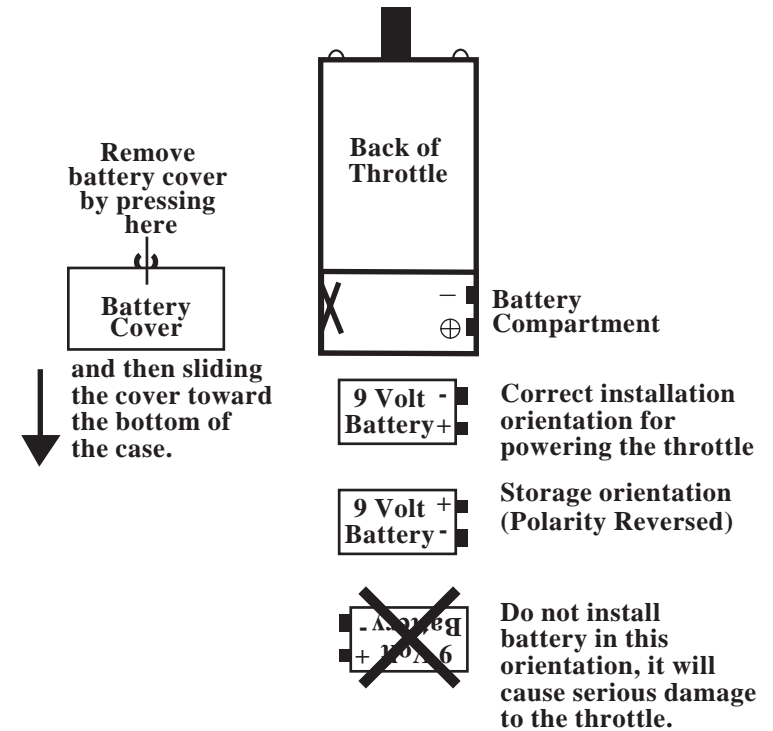

22.3 Battery Replacement

When the battery is not supplying enough power to run your throttle in tetherless mode, you will see your throttle display "Idle". When this happens, plug in to LocoNet and complete any jobs you had in progress. Loco addresses selected on your throttle will continue running until you plug in and bring them to a stop. Loco addresses selected will not be "lost" when the battery goes down. Install a fresh battery and then you can unplug again and resume tetherless operation.

23.0 Customizing Your DT400

You can set up the following options for each DT400 throttle to customize the way it operates.

You can choose between ballistic and normal tracking, whether the fast clock is displayed by default, whether the keys and knobs click when you operate them, how the throttle handles new decoders, how tetherless operation works, the brightness of the backlight in the display, whether the clock is in 24 or 12 hour

format, the depth of the recall stack, the throttle ID#, and which radio frequency the throttle will use.





To make these changes, consult the following tables to determine which option values to set up in Option #1, Option #2, Option #3, Option #4, Option #F & Option #6.

To change DT400 Option Settings

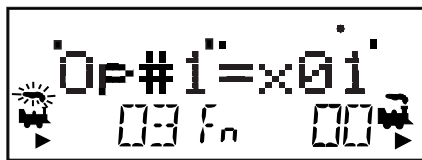
1. Consult the tables below to determine which settings you want to make for each of the 6 available option tables.



2. Press the OPTN t Key  and the display will show:



3. The right side of the display will show the current value for OP#1. The default setting for OP#1 is x01. Notice that these values are entered in hex format. The “x” in front of the value lets you know to expect to use hex numbers. Pressing the throttle keys will not change to decimal values in this case.
4. Use the R or L throttle knob to change the setting for OP#1. Set the option value selected from the table below for OP#1.
5. Press the ENTER Key  to set OP#1 to the value selected and advance to OP#2.
6. Dial in the value selected from the table below for OP#2 and Press the ENTER Key  to set OP#2 to the value selected and advance to OP#3.
7. Dial in the value selected from the table below for OP#3 and Press the ENTER Key  to set OP#3 to the value selected and advance to OP#4.
8. You should not need to change the values for OP#4, OP#F or OP#6 so press the ENTER Key  three more times to step through these options.

23.1 DT400 Option #1

23.1.1 Ballistic or Straight Line Tracking

With ballistic tracking, the faster you increase or decrease the the throttle knob, the faster the data changes in the throttle. When ballistic tracking is enabled, so are typematic keys. With typematic keys, when you press and hold the Y +  or N -  Keys, the values will continue to increase or decrease without having to do a separate key press for each increment. Your DT400 was shipped with ballistic tracking as the factory default setting.

With straight line tracking each movement of the throttle knob causes a fixed rate of change. When you use straight line tracking, typematic key action is off. This means that you must press each key once to cause an action.

23.1.2 Key & Knob Clicks On/Off

DT400 can be set up to click each time you press a key or turn one of the knobs. Some users like to have this auditory feed back and others don't. Your DT400 was shipped with key & knob clicks enabled.

23.1.3 Local/Global Stop

DT400 can be set up to handle stop commands globally or locally. The default is local control.

With local stop, when the EMRG STOP Key is pressed once the loco on the active throttle will stop and when the EMRG STOP Key is pressed a second time, the loco on the other throttle knob will stop. To resume operation, use the throttle knobs to increase speed of the locos from 0.

With global stop enabled, pressing the EMRG STOP Key will stop all locos on the layout and you will see the DT400's track power indicator blinking on and off. To resume operations, press the PWR Key followed by the Y+ Key to return locos to their speed prior to the EMRG STOP.

Table IV: DT400 Throttle Option #1 Choices

Op#1 Value (hex)			
	Ballistic Tracking & Typematic Keys	Key & Knob Clicks	Run/Stop Local/Global
x00	No	Yes	Local
x01 (Default)	Yes	Yes	Local
x04	No	No	Local
x05	Yes	No	Local
x10	No	Yes	Global
x11	Yes	Yes	Global
x14	No	No	Global
x15	Yes	No	Global

23.2 DT400 Option #2

23.2.1 Throttle Default Decoder Operation

Each DT400 can be set up to operate new decoders selected by that DT400 as any decoder status code you choose. New decoders are defined as decoders that have not been selected in your system. Your DT400 is set to expect to operate mostly decoders that are 128 speed step capable, so when a new decoder is selected the DT400 defaults to that status code. If you operate mostly decoders that are only able to recognize 28 speed steps, you can change this setting.

23.2.2 Tetherless Operation Mode

Each DT400 can be set up with radio capability and/or infrared capability enabled, all tetherless operation disabled and power save enabled or disabled. DT400 is shipped with IR only enabled and DT400R is shipped with Radio & IR enabled

Table V: DT400 Throttle Option #2 Choices

Op#2 Value (hex)	Throttle Default For Decoder Operation	Tetherless Operation Mode
x00	28 step decoder	Radio & IR
x02	14 step decoder	Radio & IR
x03 (DT300R)	128 step decoder	Radio & IR
x20	28 step decoder	IR Only Enabled
x22	14 step decoder	IR Only Enabled
x23 (DT300)	128 step decoder	IR Only Enabled
x24	28 step FX decoder	IR Only Enabled
x27	128 step FX decoder	IR Only Enabled
x28	Disable default decoder operation override	IR Only Enabled
x40	28 step decoder	Radio Only Enabled
x42	14 step decoder	Radio Only Enabled
x43	128 step decoder	Radio Only Enabled
x44	28 step FX decoder	Radio Only Enabled
x47	128 step FX decoder	Radio Only Enabled
x48	Disable default decoder operation override	Radio Only Enabled
x60	28 step decoder	IR & Radio Disabled
x62	14 step decoder	IR & Radio Disabled
x63	128 step decoder	IR & Radio Disabled
x64	28 step FX decoder	IR & Radio Disabled
x67	128 step FX decoder	IR & Radio Disabled
x68	Disable default decoder operation override	IR & Radio Disabled
x80	28 step decoder	Disable Power Save
x82	14 step decoder	Disable Power Save
x83	128 step decoder	Disable Power Save
x84	28 step FX decoder	Disable Power Save
x87	128 step FX decoder	Disable Power Save
x88	Disable default decoder operation override	Disable Power Save

23.3 DT400 Option #3

23.3.1 LCD Backlight Brightness Setting

The backlight intensity can be set for off, low, medium or high intensity. The brightness of the backlight affects battery life, the brighter the LCD, the shorter the battery life. **When your DT400 is untethered from LocoNet, the backlight automatically reduces brightness by one setting to conserve battery power.**

23.3.2 Fast Clock Format

The fast clock can be set up to run in 12 hour format or 24 hour format.

23.3.3 Recall Stack Depth

The DT400 recall feature can be set to keep a list of the last 4, 8, or 16 addresses that were selected in the throttle.

23.3.4 Tetherless Release

DT400/R's are shipped from the factory with tetherless release disabled. This prevents you from accidentally touching the LOCO Key and entering address selection while you are running your throttle in tetherless mode. DT400 can be set up to allow locos to be released from the throttle when it is in tetherless mode (IR or radio) by setting DT400 Option #3 according to the following table.

Table VI: DT400 Throttle Option #3 Set Up Choices

Op#3 Value (hex)	Backlight Brightness	Clock Format	Recall Stack Depth	Tetherless Release
x00	Off	12 hour format	4	No
x01	Low intensity	12 hour format	4	No
x02	Medium intensity	12 hour format	4	No
x03	High intensity	12 hour format	4	No
x04	Off	24 hour format	4	No
x05	Low intensity	24 hour format	4	No
x06	Medium intensity	24 hour format	4	No
x07	High intensity	24 hour format	4	No
x08	Off	12 hour format	4	Yes
x09	Low intensity	12 hour format	4	Yes
x0A	Medium intensity	12 hour format	4	Yes
x0B	High intensity	12 hour format	4	Yes
x0C	Off	24 hour format	4	Yes
x0D	Low intensity	24 hour format	4	Yes
x0E	Medium intensity	24 hour format	4	Yes
x0F	High intensity	24 hour format	4	Yes
x10	Off	12 hour format	8	No
x11	Low intensity	12 hour format	8	No
x12	Medium intensity	12 hour format	8	No
x13	High intensity	12 hour format	8	No
x14	Off	24 hour format	8	No
x15	Low intensity	24 hour format	8	No
x16	Medium intensity	24 hour format	8	No
x17	High intensity	24 hour format	8	No
x18	Off	12 hour format	8	Yes
x19	Low intensity	12 hour format	8	Yes
x1A	Medium intensity	12 hour format	8	Yes
x1B	High intensity	12 hour format	8	Yes
x1C	Off	24 hour format	8	Yes
x1D	Low intensity	24 hour format	8	Yes
x1E	Medium intensity	24 hour format	8	Yes
x1F	High intensity	24 hour format	8	Yes

**Table VI: DT400 Throttle Option #3 Set Up Choices
(Continued)**

Op#3 Value	Backlight Brightness	Clock Format	Recall Stack Depth	Tether-less Release
x20	Off	12 hour format	16	No
x21	Low intensity	12 hour format	16	No
x22	Medium intensity	12 hour format	16	No
x23	High intensity	12 hour format	16	No
x24	Off	24 hour format	16	No
x25	Low intensity	24 hour format	16	No
x26	Medium intensity	24 hour format	16	No
x27	High intensity	24 hour format	16	No
x28	Off	12 hour format	16	Yes
x29	Low intensity	12 hour format	16	Yes
x2A	Medium intensity	12 hour format	16	Yes
x2B	High intensity	12 hour format	16	Yes
x2C	Off	24 hour format	16	Yes
x2D	Low intensity	24 hour format	16	Yes
x2E	Medium intensity	24 hour format	16	Yes
x2F	High intensity	24 hour format	16	Yes

23.4 DT400 Option #4

Option # 4 sets the throttle ID of your throttle. Each throttle in your LocoNet system has its own unique ID. We do not recommend changing this ID but if you choose to do so, the range of values 00-FF (hex) and you must be sure that every throttle in your system has a unique ID #.

23.5 DT400 Option #F

Option #F sets the radio frequency used by the throttle when in radio mode. This setting is x0A. This value is informational only, users are not able to change this value.

23.6 DT400 Option #6

Option #6 sets the throttle type. All DT400's are throttle type x44. You should not change this value.

24.0 FCC Information

Radio or TV Interference: (this information is MANDATED by the FCC)
This equipment has been tested and found to comply with the limits for a Class B digital device, pursuant to part 15 of the FCC rules. These limits are designed to provide reasonable protection against harmful interference in a residential environment. This equipment generates, uses and can radiate radio frequency energy and, if not installed and used in accordance with the instruction manual, may cause harmful interference to radio communications. However, there is no guarantee that interference will not occur in a particular installation. If this equipment does cause harmful interference to radio or television reception, which can be determined by turning the equipment off and on, the user is encouraged to try to correct the interference by one or more of the following measures:

- Reorient or relocate the receiving antenna.
- Increase the separation between the equipment and the receiver.
- Connect the equipment into an outlet on a circuit different from that to which the receiver is connected.
- Consult the dealer or an experienced radio/TV technician for help.

Note that any modifications to the equipment not expressly approved by Digitrax voids the user's authority to operate under and be in compliance with CFR 47 rules, as administered by the Federal Communication Commission. Digitrax believes any conscientiously installed equipment following guidelines in this manual would be unlikely to experience RFI problems.

The DT400R is certified for "unlicensed" operations within the United States by the US FCC and has the identifier as displayed on the unit case. Canadian ID for DT400R is displayed on the unit case. See unit case for certification identifiers from other countries.

Important Note: The DT400R is certified by the FCC and by Industry Canada using a 12" LocoNet cable only. Any modification to the cable may void the certification. For convenience an extension cord may be attached with a 6 pin adapter for tethered use only.

For Canadian Users:

"This digital apparatus does not exceed the Class B limits for Radio noise emission from digital apparatus set out in the Radio Interference Regulation or the Canadian Department of Communications."

Le present appareil numerique n emet pas de bruits radio-electriques depassant les limites applicables aux appareils numeriques de la classe B prescrites dans le Reglement sur le brouillage radioelectrique edicte par le ministere des Communications du Canada.

25.0 Warranty and Repair Information

Digitrax gives a one year guarantee against manufacturing defects on the DT400 and DT400R. These units are not user serviceable (opening the case voids your warranty). If a defect occurs, return the unit to us for service. We will repair or replace these units at our discretion at no charge to you for one year from purchase date. This warranty excludes damage due to abuse, such as failure to properly protect against input over current with a fuse or circuit breaker or applying excessive input voltage to the unit. We will make any repair needed because of physical damage or electrical abuse at fair and reasonable rates.

Please call tech support at (770) 441-7992 before you send anything to us for service so that we can try and resolve the problem by phone if possible.

All warranties on Digitrax products are limited to refund of purchase price or repair or replacement of Digitrax products at the sole discretion of Digitrax. In the event that Digitrax products are not installed or used in accordance with the manufacturer's specifications, any and all warranties either expressed or implied are void. Except to the extent expressly stated in this section, there are no warranties, express or implied, including but not limited to any warranties of merchantability or fitness for a particular purpose.

Units for repair should be sent to:

Digitrax, Inc. Repair Department
450 Cemetery ST #206
Norcross, GA 30071 USA

Be sure to include your name, address, day time phone number, and a complete description of the problem with your unit.

Digitrax, Inc. reserves the right to make changes in design and specifications, and/or to make additions or improvements in its products without imposing any obligations upon itself to install these changes, additions or improvements on products previously manufactured.

Index

2 digit addressing 29, 47
4 digit addressing 29, 47

A

acceleration 36, 50, 66
Analog Operation 9, 10, 11, 13, 18, 29, 47

B

BACK Key 24, 62
ballistic tracking 16, 24, 70, 75
Bar Graph 13, 20, 31, 32, 34, 56
basic consisting 39
battery 7, 16, 66, 67, 71, 72, 73, 78
Bell 1 Key 26

C

cascaded routes 60
CLOC c Key 25, 57, 62, 63
closed 23, 25, 56, 57, 59, 60, 62, 63, 66
configuration variables 43, 47
Consist 5, 23, 34, 38, 40, 41, 42, 43, 54, 55, 65, 70
Control Lock 71
Coupler 3 Key 26
Customizing Your DT300 73
CV 12, 26, 34, 36, 43, 44, 45, 46, 47, 48, 49, 50, 52, 53, 66

D

DCC Address Ranges & Display 28
deceleration 34, 36, 50
decoder status 20, 54, 76
Direct mode 46, 52
direction 5, 7, 9, 10, 11, 12, 13, 14, 16, 17, 23, 28, 29, 31, 33, 36, 38, 39, 40, 54, 56, 69, 72
direction indicators 9, 17, 40, 56
DISP Key 24, 42, 43, 52, 53
dispatching addresses 42, 64

E

EDIT Key 24, 55, 58, 59, 61, 68
EMRG STOP Key 25, 35, 75
ENTER Key 25, 31, 47, 49, 51, 53, 55, 62, 69, 74
EXIT Key 20, 25, 33, 35, 47, 49, 51, 53, 57, 59, 63, 65

F

fast clock 20, 24, 57, 58, 59, 68, 71, 73, 78
FCC Information 81
FIND Key 5, 24, 63, 64
flashlight 5, 25
FUNC Key 23, 37, 57
functions 5, 7, 9, 13, 14, 18, 21, 26, 28, 31, 36, 38, 57

G

global stop 26, 35, 75

H

Horn 2 Key 26, 37

I

InfraReady 5, 66
infrared 4, 22, 27, 39, 41, 42, 43, 45, 50, 52, 66, 68, 69, 71, 76

K

key & knob clicks 75

L

L & R Reverse Keys 10, 11, 13, 23, 28, 31, 36, 49
LAMP 0 Key 37
LCD backlight 78
Local Stop 35, 75
Loco Icon 17
LOCO Key 10, 11, 12, 29, 31, 32, 38,

42, 43, 54, 70, 78
LocoNet 4, 22, 27, 33, 39, 41, 42, 45,
50, 55, 58, 60, 65, 66, 69, 73, 80
LocoNet ID 67, 68

M

Mode Indicator 19, 20, 26, 29, 32, 36,
40, 46, 48, 50, 52, 59, 61, 68
MU Key 23, 40, 41

N

N - Key 9, 23, 24, 28, 34, 35
nested route 60
Non-Digitrax decoder 46, 54, 55
normal walkaround operation 16
numeric keypad 5, 9, 12, 20, 23, 26,
28, 29, 36, 37, 48, 53, 56

O

ops mode programming 45, 46, 48, 50,
51, 70
option settings, DT400 25, 32, 35, 55,
58, 70, 71, 73, 74, 76, 78, 80
OPTN t Key 25, 26, 57, 62, 63, 74

P

Paged programming mode 46, 52
Physical register mode 46, 52
power save mode 67, 68
PROG Key 24, 45, 46, 48, 50, 52, 70
programming CV's other than address-
es 48
programming decoder addresses 45
PWR Key 24, 26, 27, 28, 35, 38, 47,
49, 53, 64, 75

R

radio operation 4, 7, 16, 22, 39, 41, 42,
43, 45, 50, 66, 67, 68, 69, 71, 74, 76,
78, 80, 81
recall 17, 32
releasing an address 42, 64, 70
route 24, 56, 57, 59, 60, 62, 63, 70

routes 59

S

Safety Selection 69
SEL Message 5, 7, 9, 10, 12, 28
select a loco to run 12, 28, 29
semaphores 22
Shut Down and Resume Procedures 64
Slot Following 33
slot=max 33, 66
smoke icon 18
speed control 34
status editing a decoder 24, 54, 55
Stealing 31, 32, 54, 55, 65
straight line tracking 16, 24, 75
SWCH Key 23, 56, 63
switch mode 10, 25, 28, 55, 57, 70

T

tetherless 4, 22, 27, 42, 45, 66, 67, 69,
70
tetherless release 70
Text Area 13, 20, 29, 31, 32, 33, 46,
52, 54, 55, 56, 59, 61, 72
throttle default decoder operation 76
throttle ID 80
Throttle Knobs 7, 10, 11, 12, 16, 17,
21, 28, 29, 30, 31, 34, 35, 36, 39, 46,
47, 50, 52, 53, 54, 56, 59, 62, 68, 74,
75
throttle type 80
TOP 39
TOP loco 41
track power 8, 22, 23, 26, 27, 28, 35,
47, 49, 51, 53, 64, 65
TRACK STATUS 8, 11, 26, 27, 64, 65,
75
Troubleshooting 65
typematic 24, 75

U

UniVersal Consisting 39

W

Warranty and Repair 82

Y

Y + Key 23, 24, 26, 28, 35, 47, 49, 53,
65, 71, 75

Z

zero Speed 34